





## Electrical Optical Characteristics at Ta=25

Parameter	Symbol	Min.	Typ.	Max.	Unit	Test Condition
Radiant Intensity	I <sub>e</sub>	6.4	8.8	---	mW/sr	I <sub>F</sub> =20mA <sup>*1 3</sup>
Viewing Angle	2 <sub>1/2</sub>	---	58	---	Deg.	I <sub>F</sub> =20mA <sup>*2</sup>
Peak Wavelength	p	830	850	870	nm	I <sub>F</sub> =20mA
Spectral Line Half- Width		---	50	---	nm	I <sub>F</sub> =20mA
Forward Voltage	V <sub>F</sub>	1.10	1.40	1.60	V	I <sub>F</sub> =20mA
Reverse Current	I <sub>R</sub>	---	---	10	μA	V <sub>R</sub> =5V

### Note:

1. Point sources of the amount of radiation per unit time in a given direction within the unit solid Angle radiated energy.
- 2 <sub>1/2</sub> is the off-axis angle at which the Radiant Intensity is half the axial Radiant Intensity.
3. The I<sub>e</sub> guarantee should be added ±15% tolerance.

## Typical Electrical / Optical Characteristics Curves (25 Ambient Temperature Unless Otherwise Noted)

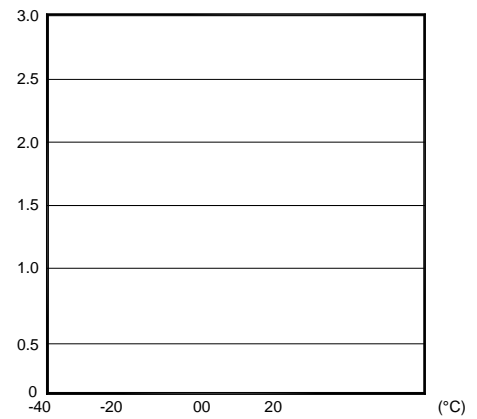
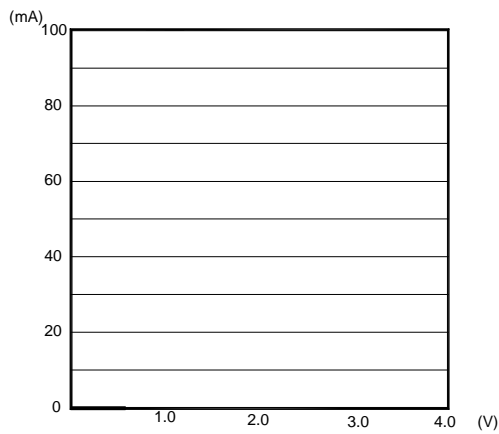



## Radiant Intensity Bin Code ( $I_F=20\text{mA}$ )

BIN CODE	Min. (mW/sr)	Max. (mW/sr)
24	6.4	7.7
25	7.7	9.2
26	9.2	11.0
27	11.0	13.0
...	...	...



**NOTE:** The  $I_e$  guarantee should be added  $\pm 15\%$  tolerance.

## Label Explanation

LIGHT Universal Label  
(Reel Label)

<b>LIGHT</b>		
Light Electronics CO., LTD.		
MODEL NAME: _____		LOT NO. : _____
QUANTITY: _____		
BI N: _____		
PACKING DATE: _____		
REMARKS: _____		

Customer Defined Label  
(Aluminum Moisture Proof Bag Label)

<b>LIGHT</b>		
Light Electronics CO., LTD.		
MODEL NAME: _____		LOT NO. : _____
QUANTITY: _____		
BI N: _____		
PACKING DATE: _____		
CUSTOMER P/N: _____		

## Reel Dimensions

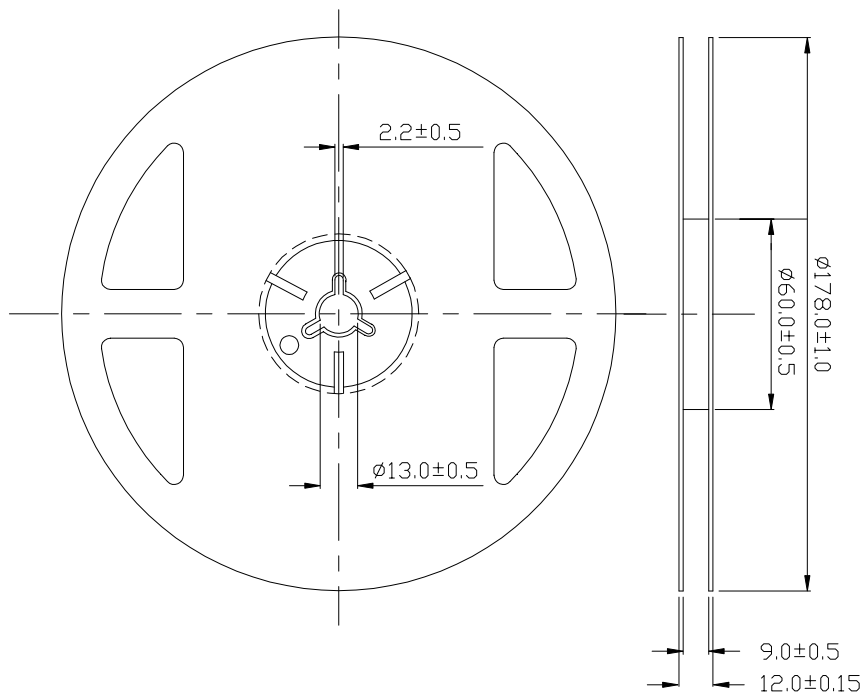

**Note:** Tolerance unless mentioned is  $\pm 0.2$ mm; Unit = mm

LIGHT



## Suggest IR Reflow Condition For Lead Free

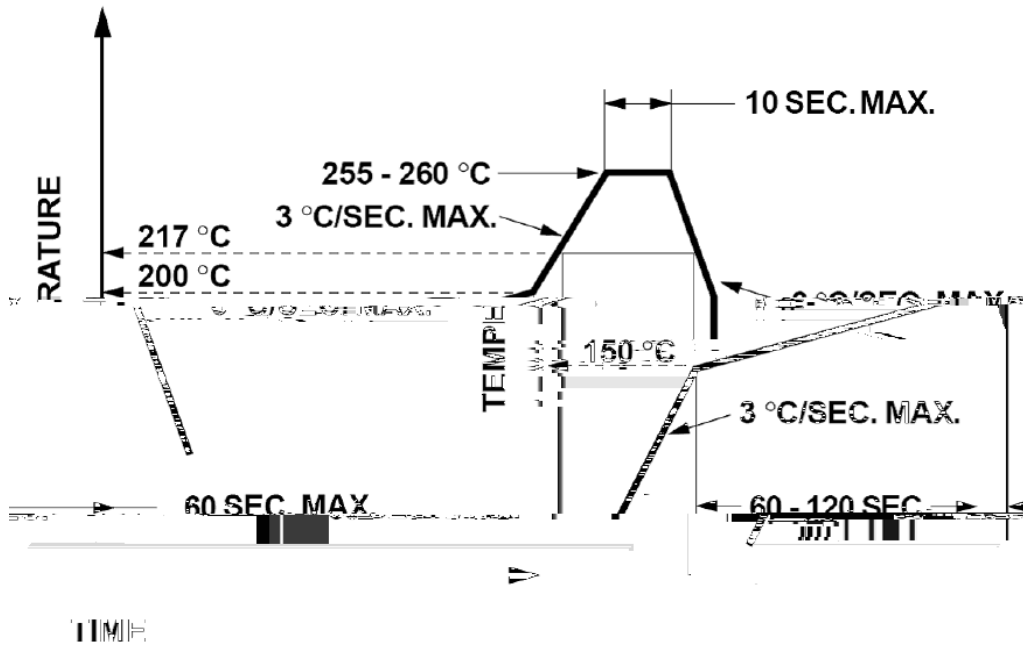

1. Reflow soldering should not be done more than two times.
2. When soldering, do not put stress on the LEDs during heating.

## Soldering iron

1. When hand soldering, the temperature of the iron must less than 300 for 3 seconds.
2. The hand solder should be done only once.

## Repairing

Repair should not be done after the LEDs have been soldered. When repairing is unavoidable, a double-head soldering iron should be used (as below figure). It should be confirmed beforehand whether the characteristics of LEDs will or will not be damaged by repairing.

