

LG-T2727RGBA-TD-A

DATA SHEET

SPEC.NO. : SZ19081205
DATE : 2020/05/07
REV. : A/1

Approved By:

Checked By:

Prepared By:



LG-T2727RGBA-TD-A

TOP Full-color LED

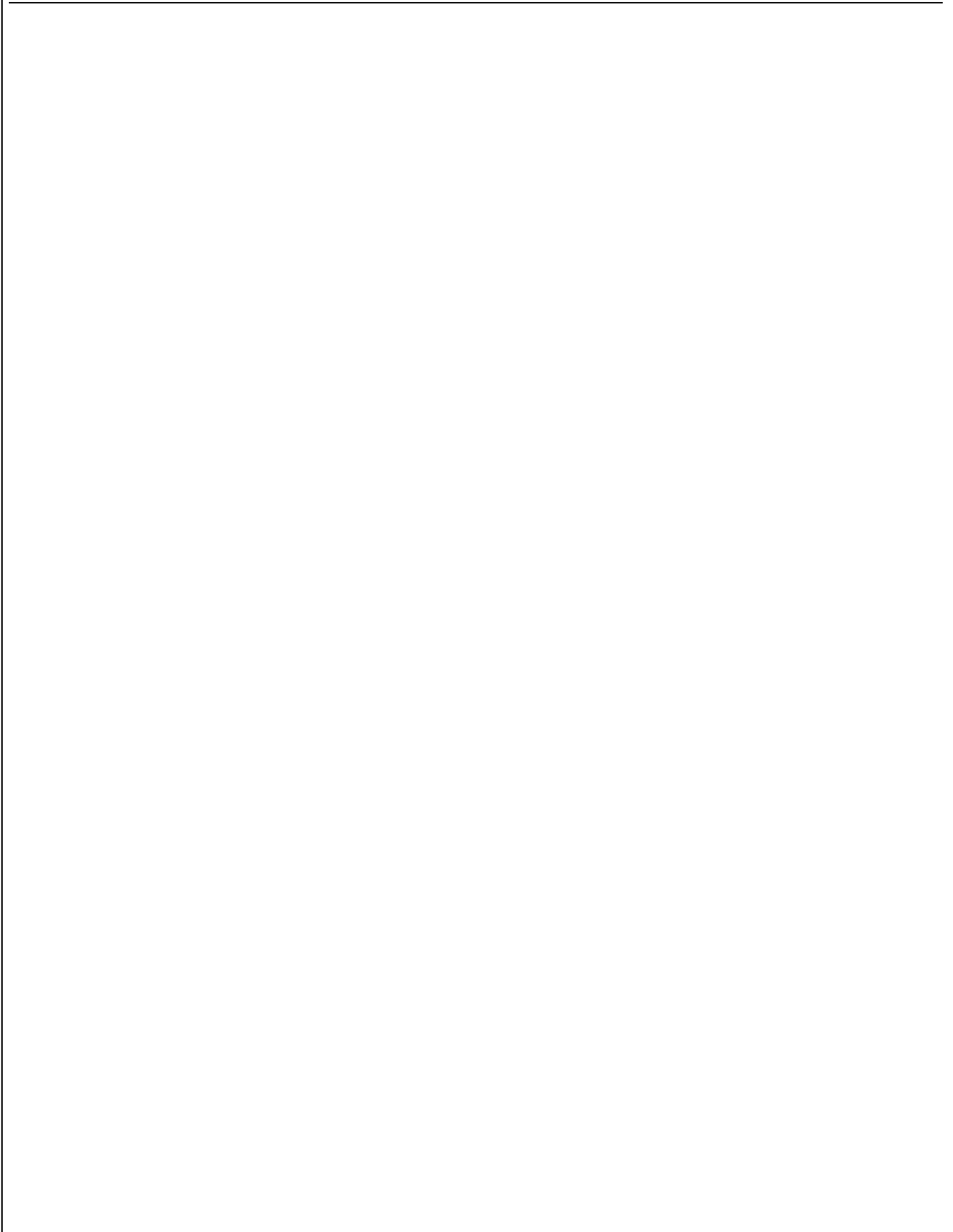

LIGHT

LIGHT ELECTRONICS CO., LTD.

Typical Characteristics Curves

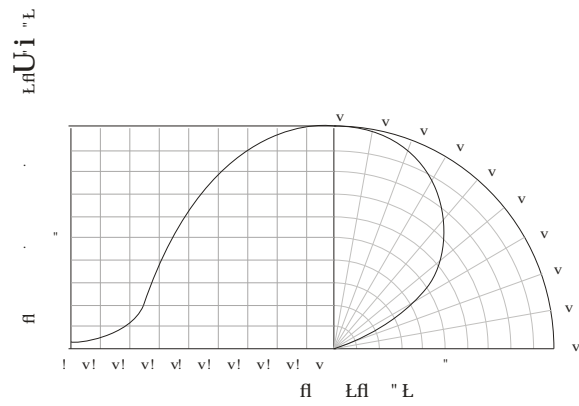
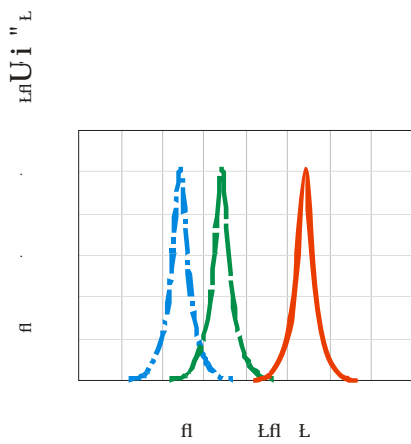
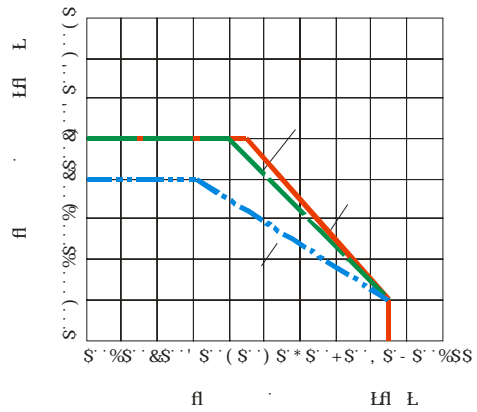
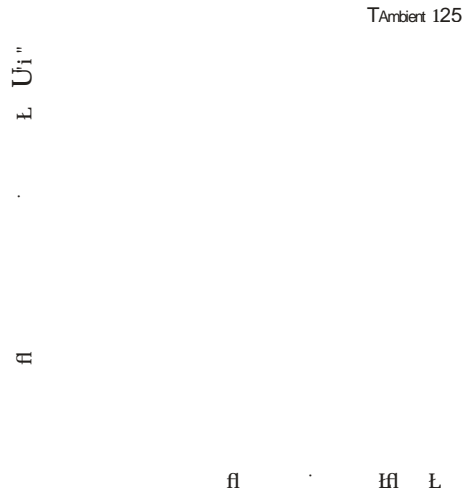
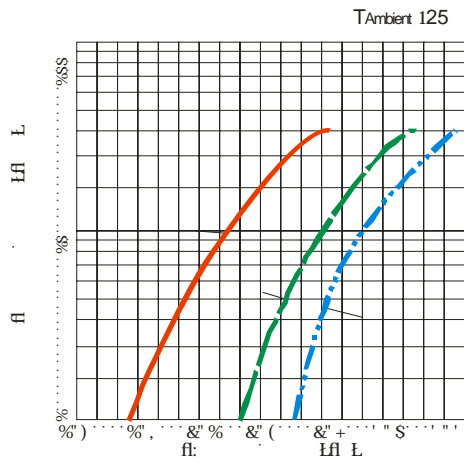

LIG

LIGHT ELECTRONICS CO., LTD.

1

Packaging (1)

◇ Carrier Tape

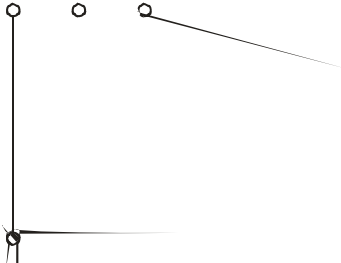

◇ Details Of Carrier Tape

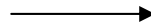

◇ Reel Dimension

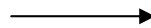

2

Packaging(2)



· **Moisture Proof and Anti-Electrostatic Foil Bag**

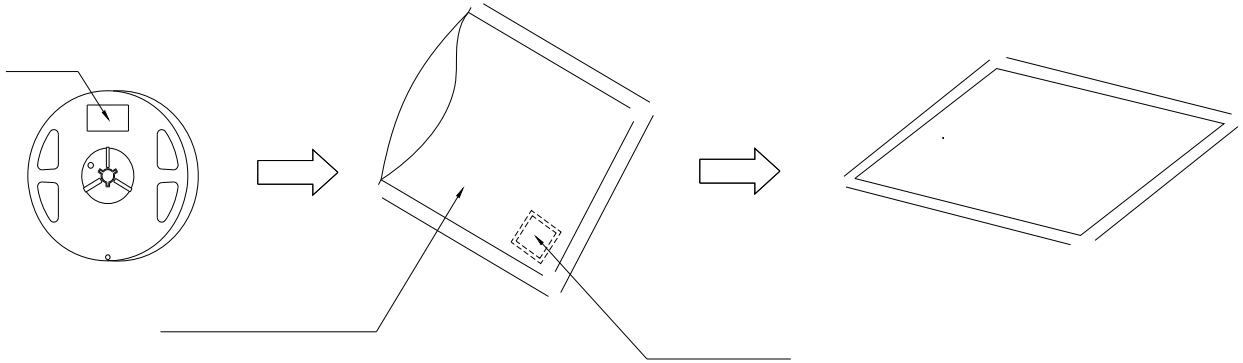

· **Cardboard Box**



· **Label Explanation**

1

Guideline for Soldering (1)

- 1. Hand Soldering

•

ž

•

•

•

Reflow Soldering:

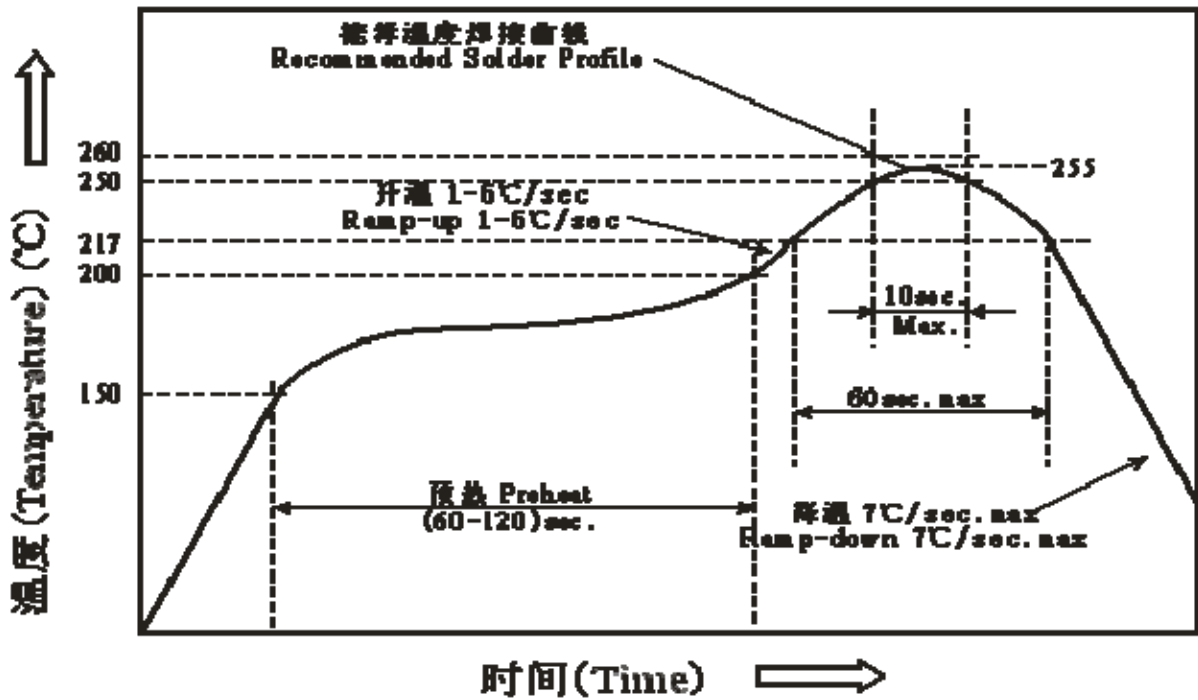

2

Guideline for Soldering (2)

- x .
- x .
- x .
- x .
- x .



(1)

Precautions (1)

1.

Storage

•

•

•

•

•

y

y

y

2.

Static Electricity

•

•

•

(2)

Precautions (2)

3.

Design Consideration

•

•

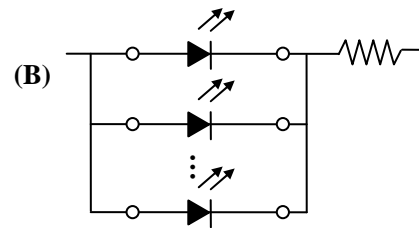
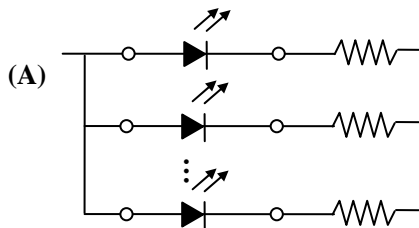

•

4.

Reverse voltage protection

•

•

(3)

Precautions (3)

5.

The safe temperature for LEDs working

-

6.

Others

-

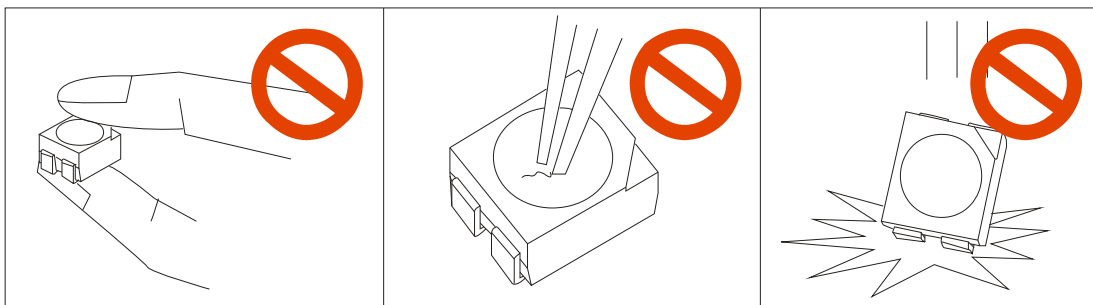

-