

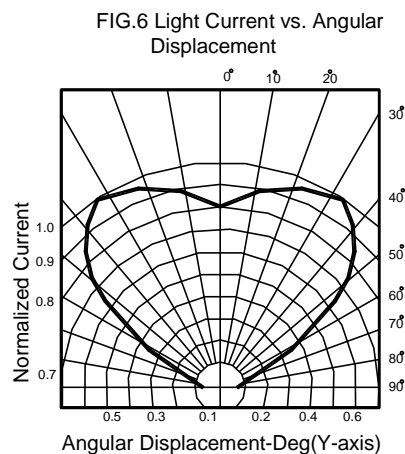

Absolute Maximum Ratings at Ta=25

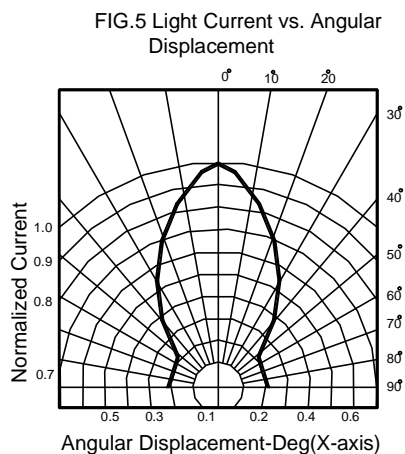

Typical Electrical / Optical Characteristics Curves (25 Ambient Temperature Unless Otherwise Noted)

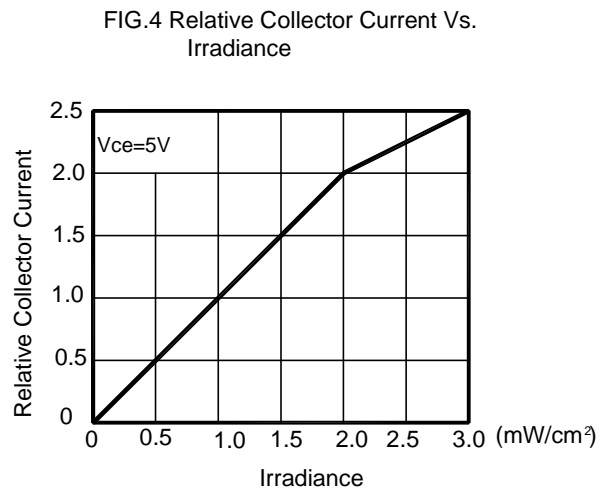
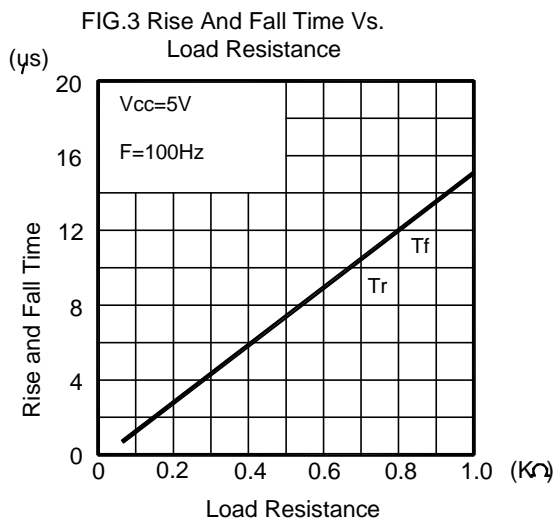
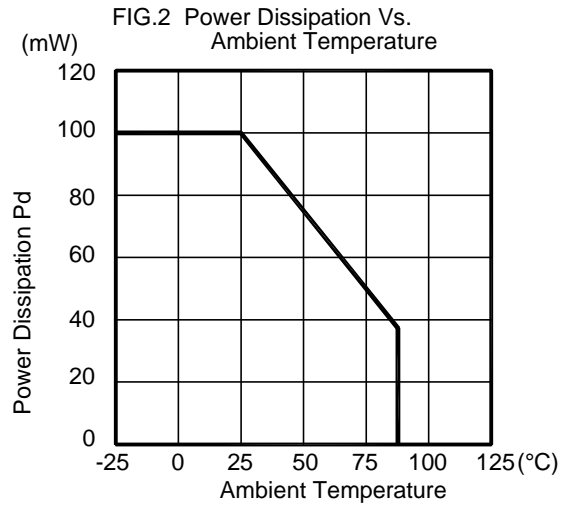
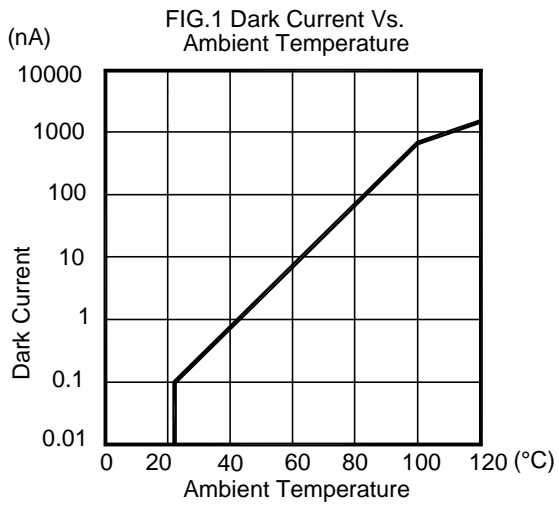

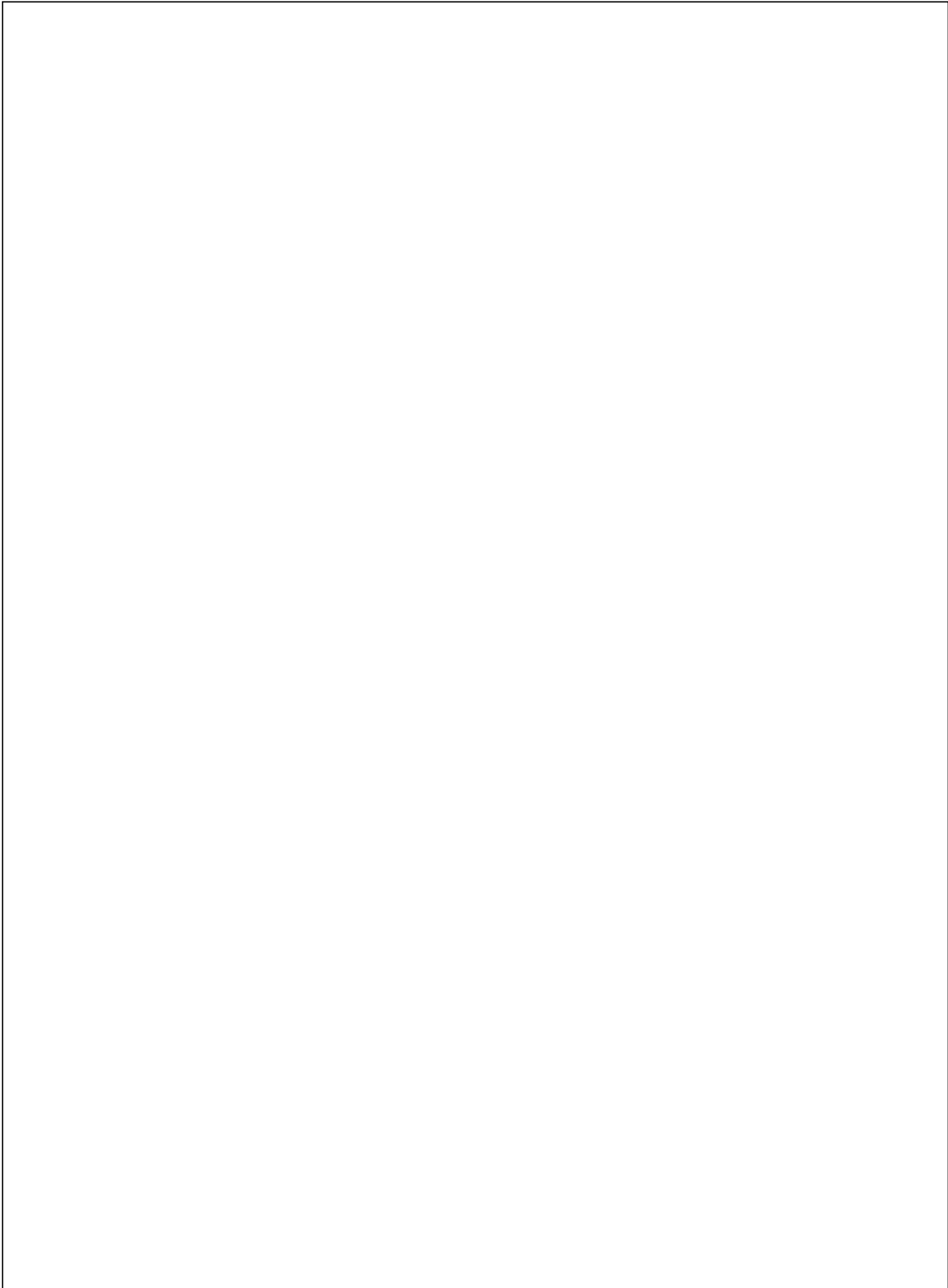

Part No.	SL-T3010PTB020-L200-Q	Page	6 of 9
-----------------	------------------------------	-------------	---------------

LIGHT	深圳莱特光电股份有限公司 Light Electronics CO., LTD.	
TYPE NO. :	_____	
QUANTITY :	_____	
BIN :	_____	
DATE CODE :	_____	
REMARKS :	_____	

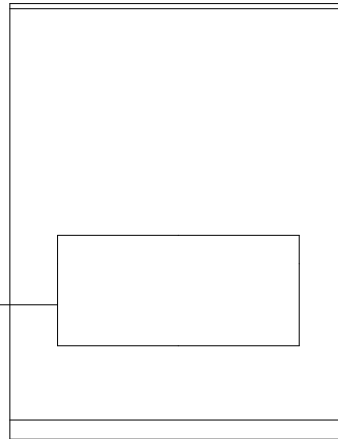

Bag

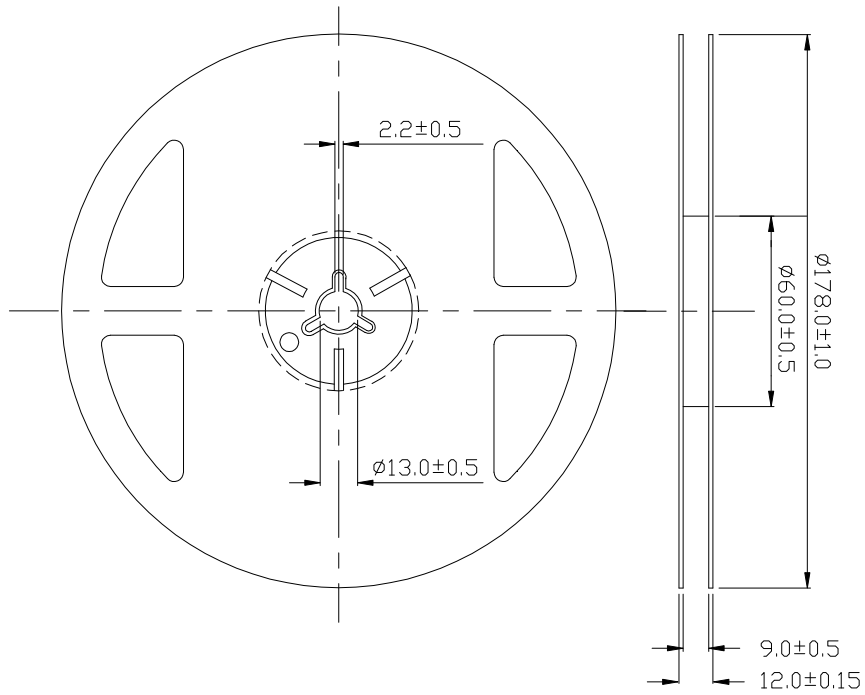

Note:

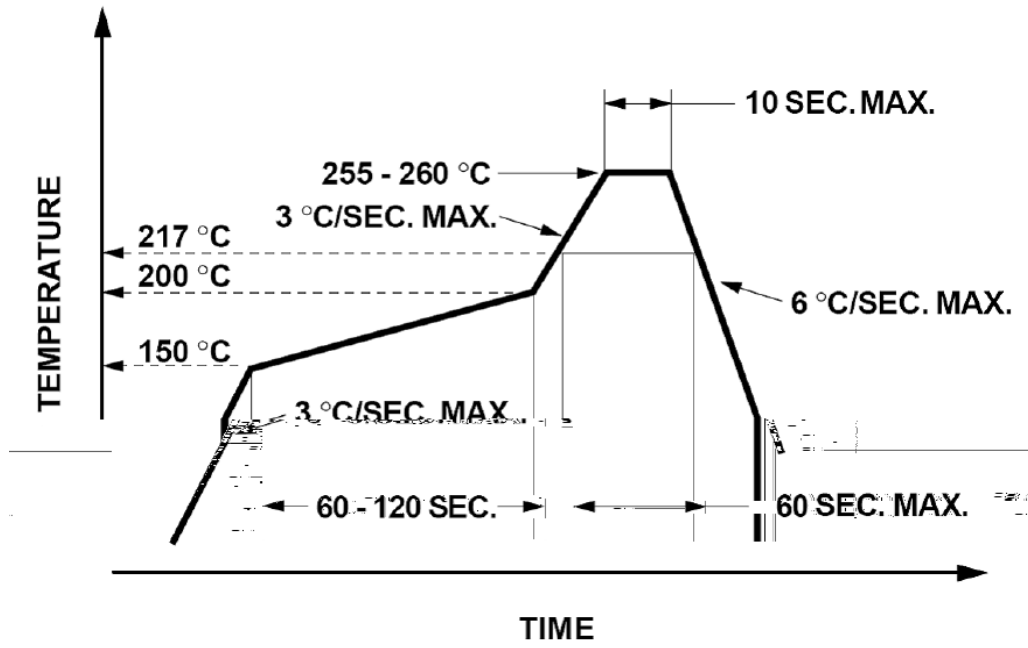

°C

