

LIGH



## Features

- ◆ Pb free product    RoHS compliant    Pb                      ROHS
- ◆ High Photo Sensitivity
- ◆ General purpose leads
- ◆ Reliable and rugged
- ◆ Long life    solid state reliability

## Package Dimension

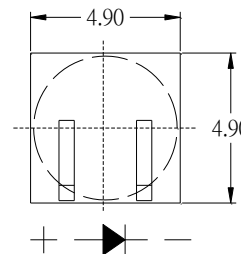
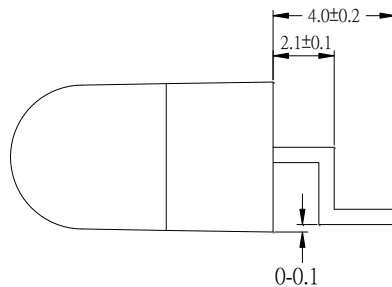
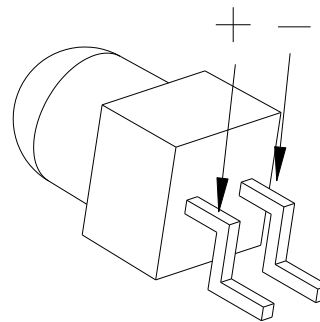
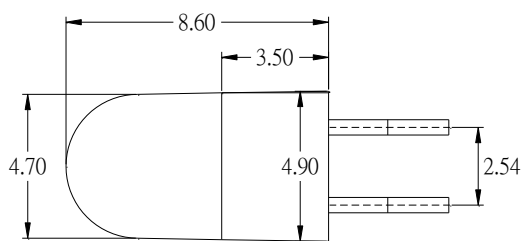

Part NO.	Chip Material	Lens Color
LG-05PD4D94K-557C-B-T	Silicon	Black

### Notes:

1. All dimensions are in millimeters.
2. Tolerance is  $\pm 0.20$ mm unless otherwise noted.  
 $\pm 0.2$  .

LIG

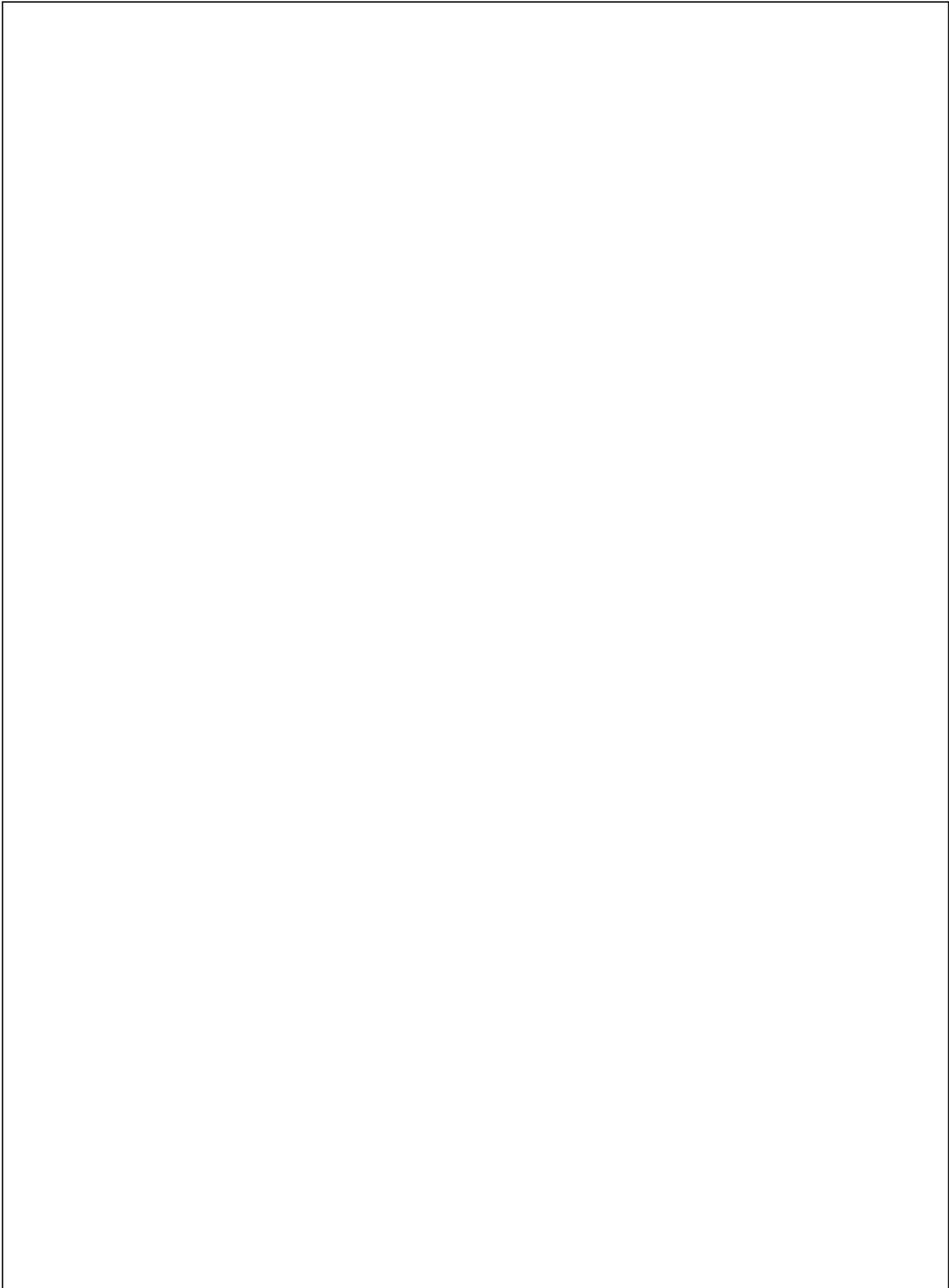



**Typical Electrical / Optical Characteristics Curves**  
**(25 Ambient Temperature Unless Otherwise Noted)**

Coupling Characteristics

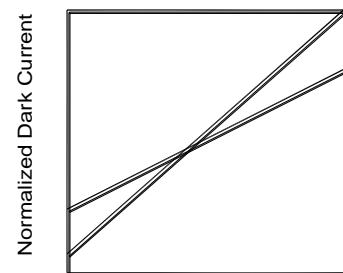
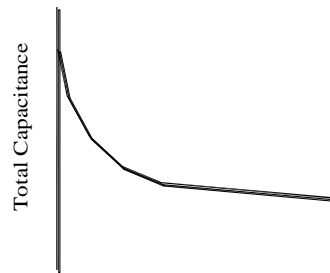
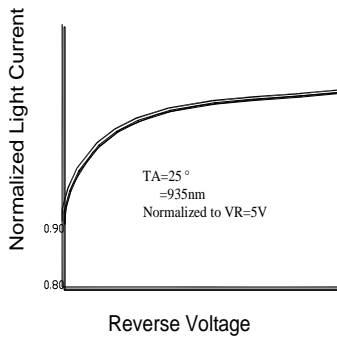
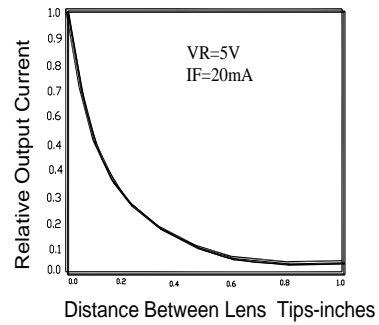

Light Current vs. Irradiance

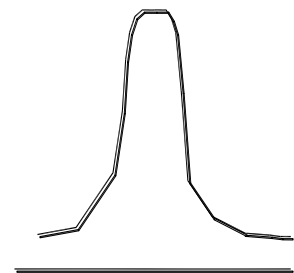
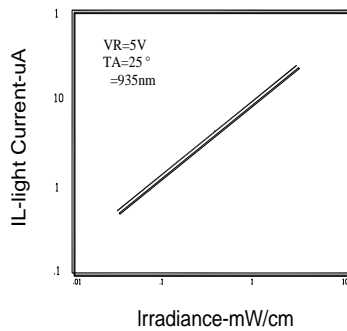

## PACKAGE

### 1. Package Dimensions

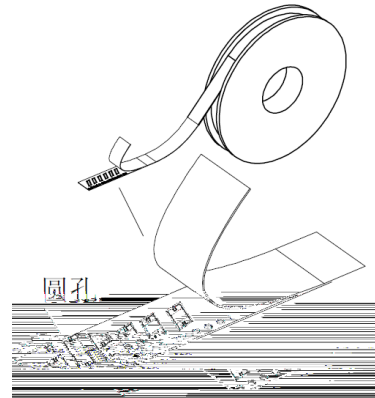
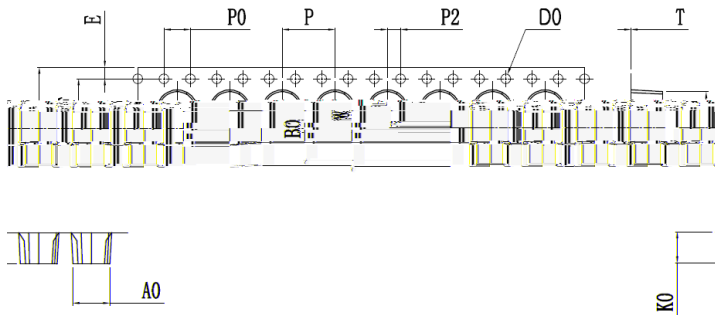

DATE LINE AFTER SOLDERING DIRECTION

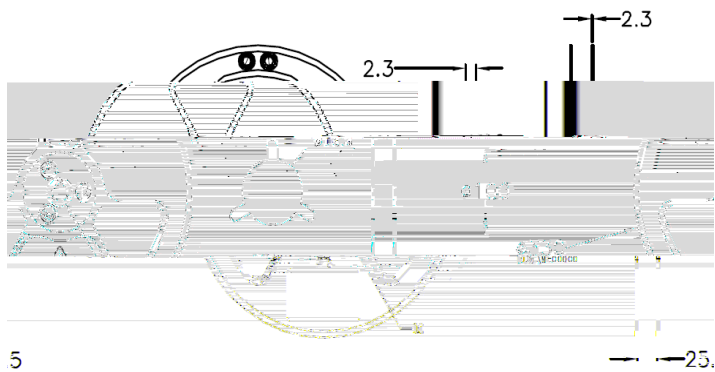

Item	Specification	
	Minum	Maximum
W	15.97	16.3
P	7.9	8.1
E	1.65	1.85
F	7.4	7.6
D	1.5	1.6
P0	3.9	4.1
P0x10	39.8	40.2
P2	1.9	2.1
A0	5.2	5.4
BO	10.6	10.8
K0	4.8	5.0

### Notes:

1. All dimensions in millimeters.
2. All dimensions meet EIA-481-C requirements.
3. Cover tape by a hot-rolling process.

- 1.
2. EIA-481-C
- 3.

L



