

# **LT-507ALS-ALI**

## **DATA SHEET**

SPEC. NO. : SZ20082101  
DATE : 2020/08/21  
REV. : A/0

Approved By:

Checked By:

Prepared By:





## 2. Functional Block Diagram

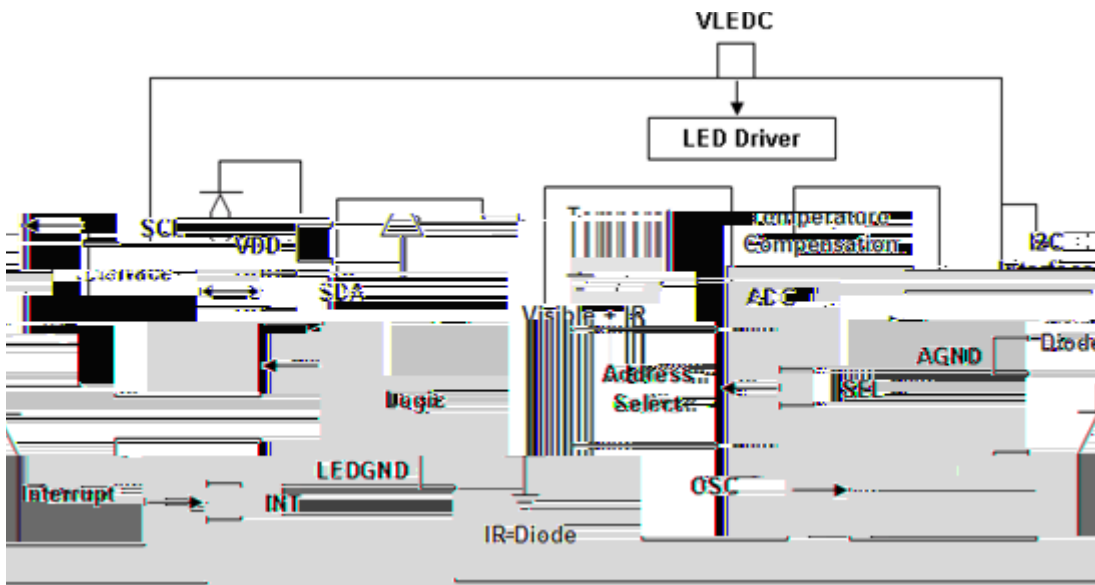

## 3. Application Circuit

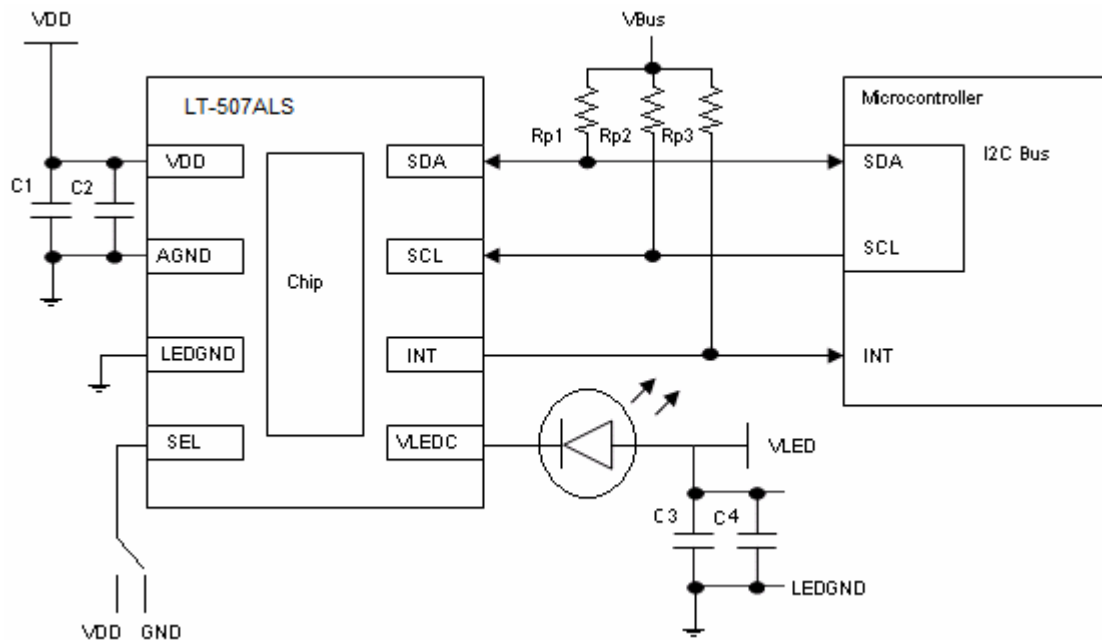

## I/O Pins Configuration Table

Pin	I/O Type	Symbol	Description
1		VDD	Supply Voltage
2		AGND	Analog Ground
3		LEDGND	LED GND
4	I	SEL	I2C address selection
5	I	VLEDC	To connect to LED Cathode.
6	O	INT	Level Interrupt pin. Active LOW for interrupt. This pin is an open drain.
7	I	SCL	I2C serial clock

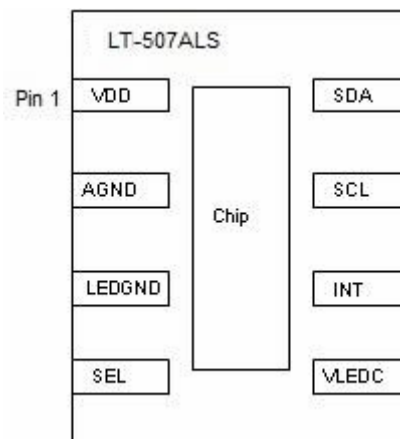

8	I/O	SDA	I2C serial data
---	-----	-----	-----------------

## Recommended Application Circuit Components

Component	Recommended Value
Rp1, Rp2, Rp3 [1]	1 k $\Omega$ to 10 k $\Omega$
C1, C3	0.1 $\mu$ F
C2, C4	4.7 $\mu$ F

### Notes:

[1] Selection of pull-up resistors value is dependent on bus capacitance values. For more details, please refer to I2C Specifications: [http://www.nxp.com/documents/user\\_manual/UM10204.pdf](http://www.nxp.com/documents/user_manual/UM10204.pdf)

[2] IR LED = LT-C249





**Part No.**

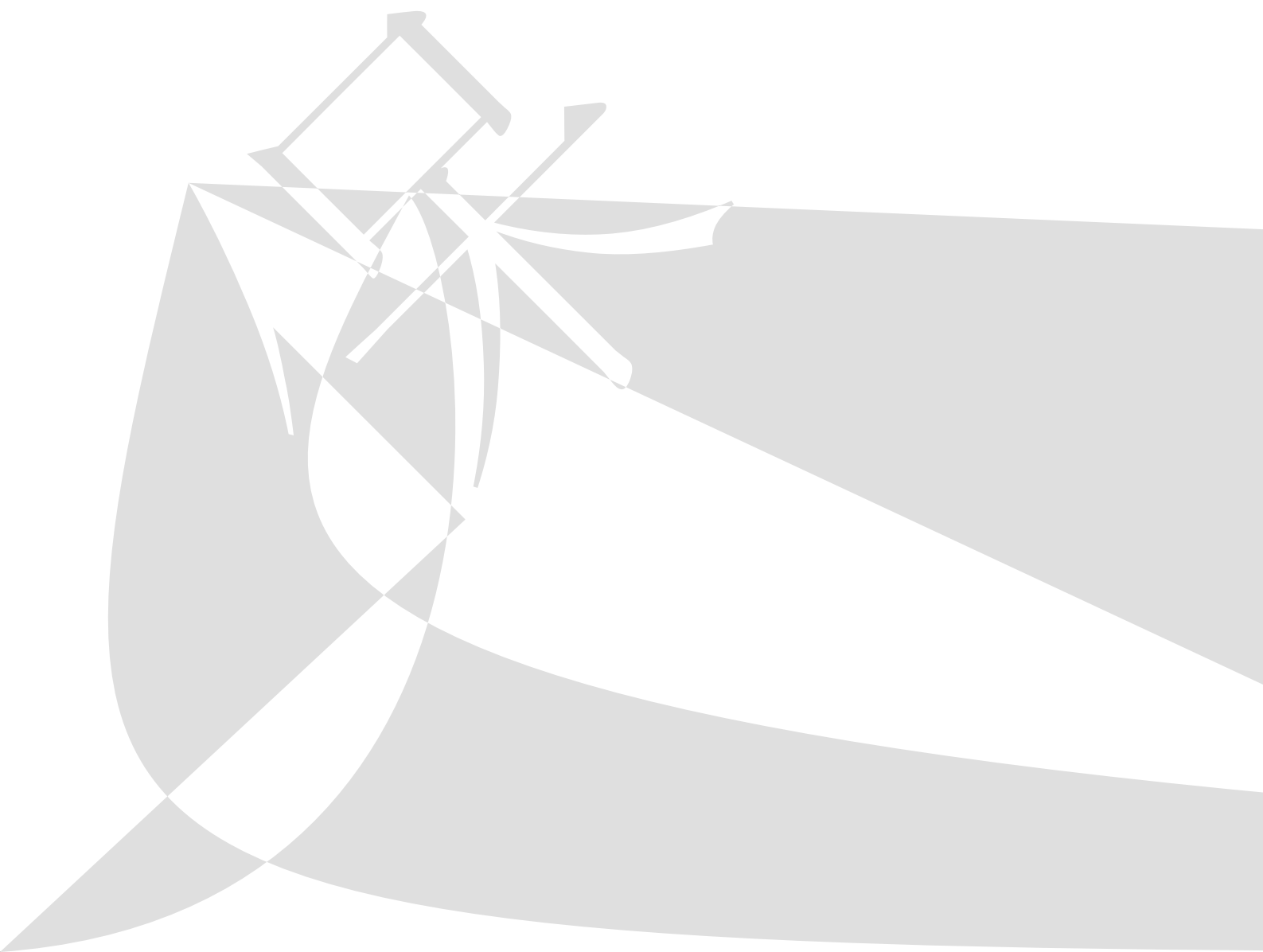



## 4.6. Typical Performance Curve, VDD = 3.0V, Ta=25°C

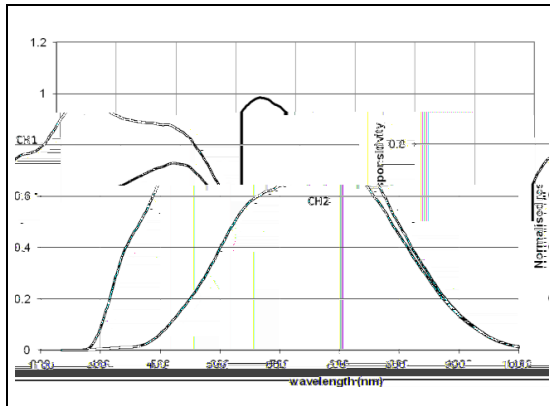

Figure 4.1 : Spectral responsivity.

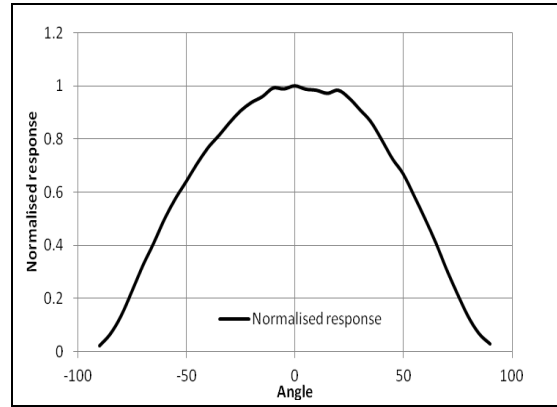

Figure 4.2 : Ambient sensor angular displacement.

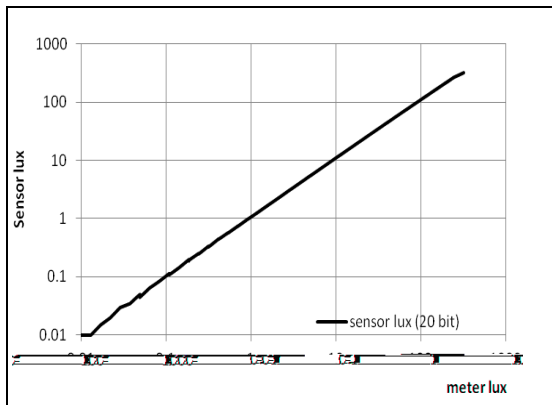

Figure 4.3: Sensor lux versus meter lux with low lux white LED source, Gain 4.

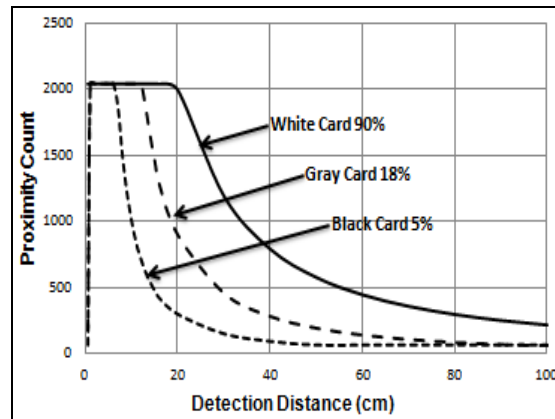
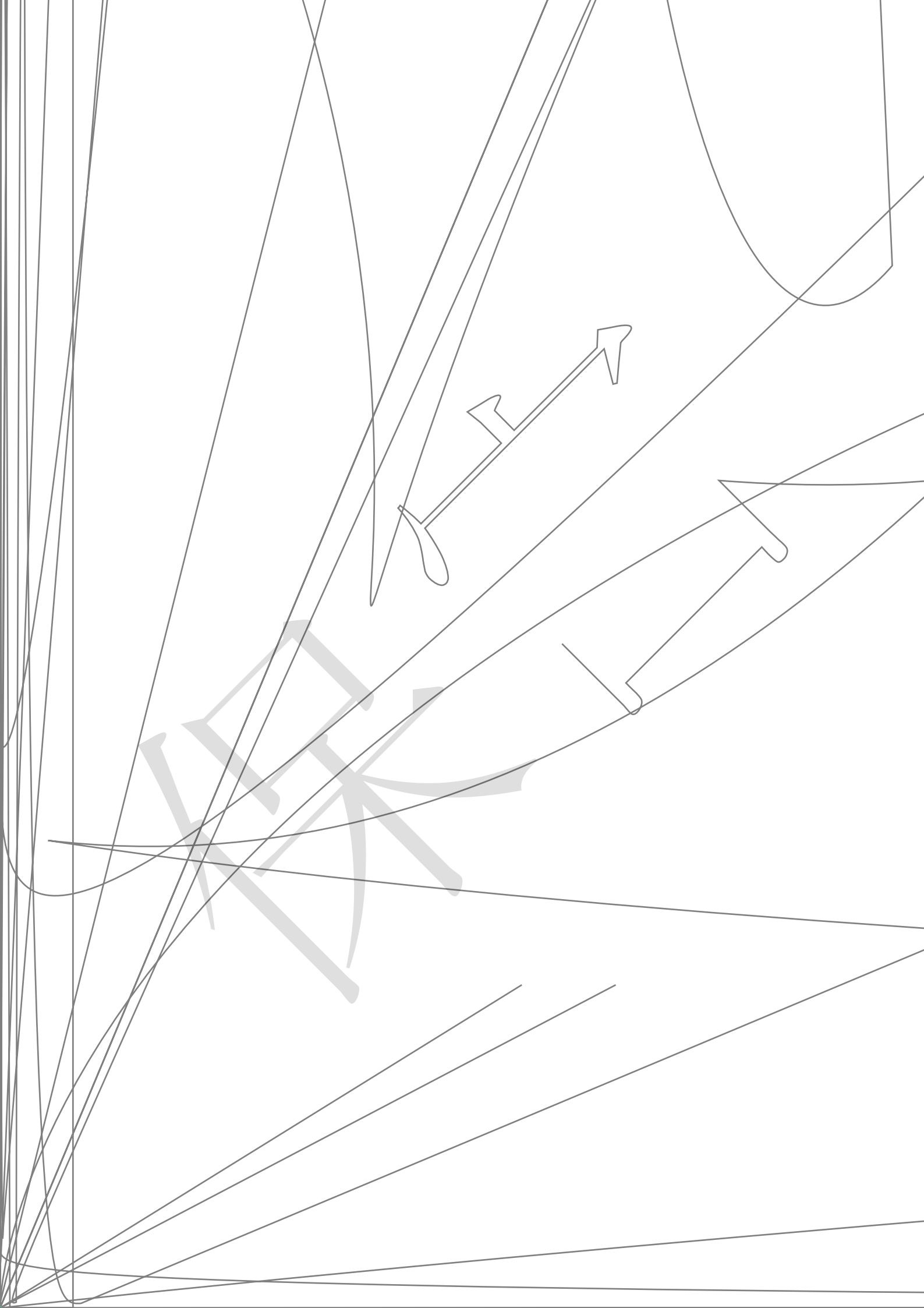
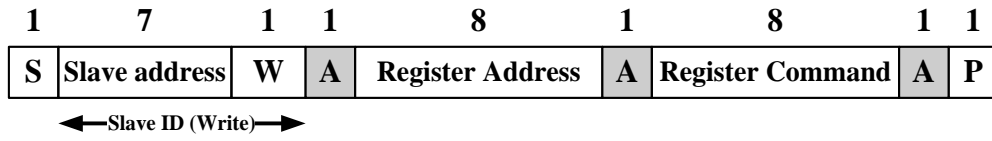

Figure 4.4 : Proximity ADC output versus detection distance (127 pulses).





### 5.1.2. I2C Write Protocol (type 2)



a

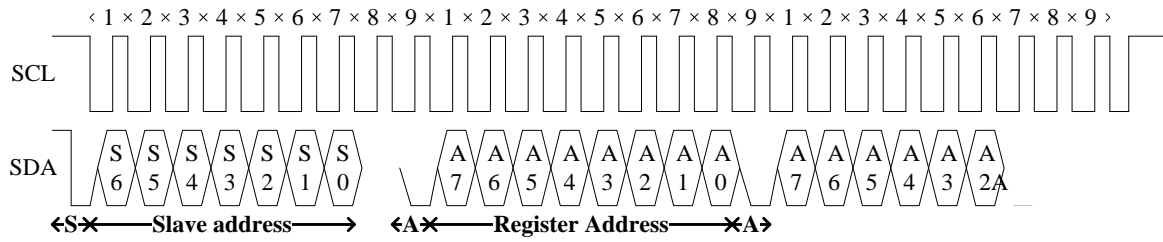

LIG

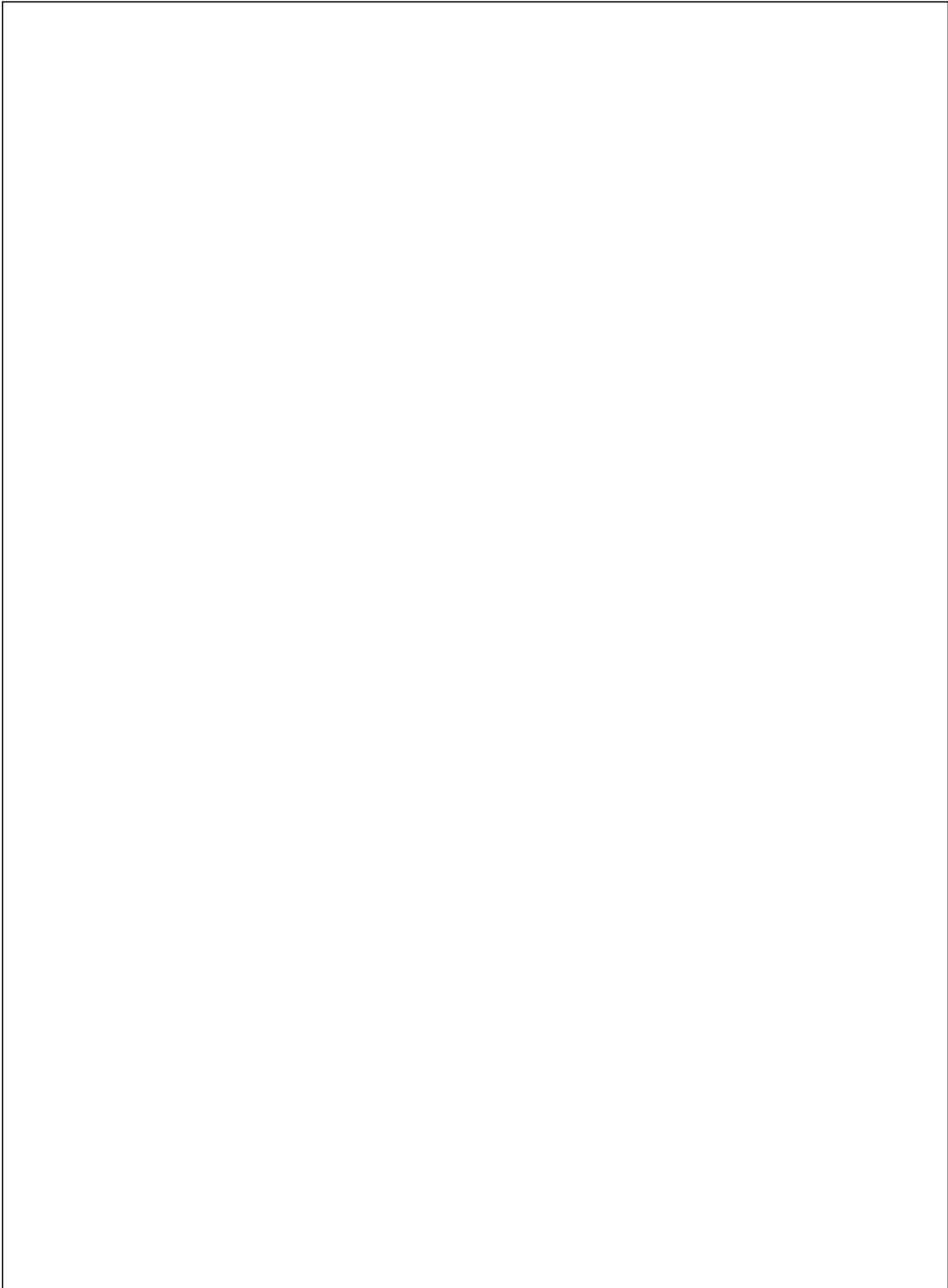

<b>Part No.</b>	<b>LT-507ALS-ALI</b>	<b>Page</b>	<b>13 of 40</b>
-----------------	----------------------	-------------	-----------------





LIGH





## 6.1. ALS\_CONTR Register (Address: 0x80)

The ALS\_CONTR register controls the ALS operation modes and software (SW) reset for the sensor. The ALS sensor can be set to either standby mode or active mode. At either of these modes, the I2C circuitry is always active. The default mode after power up is standby mode. During standby mode, there is no ALS measurement performed but I2C communication is allowed to enable read/write to all the registers

0x80	ALS_CONTR (default = 0x00)							
	Bit 7	Bit 6	Bit 5	Bit 4	Bit 3	Bit 2	Bit 1	Bit 0
	<i>Reserved</i>			<i>ALS Gain</i>		<i>SW Reset</i>	<i>ALS Mode</i>	<i>Reserved</i>

Field	BITS	Description
Reserved	7:5	Must write as 0
ALS Gain	4:3	00: Dynamic Range 1 (1 lux to 64k lux) (1 lux / count) (default) 01: Dynamic Range 2 (0.5 lux to 32k lux) (0.5 lux / count) 10: Dynamic Range 3 (0.02 lux to 640 lux) (0.01 lux / count) 11: Dynamic Range 4 (0.01 lux to 320 lux) (0.005 lux / count)
SW Reset	2	0: Software reset is NOT started (default) 1: Software reset is started, default value after reset is 0
ALS Mode	1	0: Standby Mode (default) 1: Active Mode
Reserved	0	Must write as 0

## 6.2. PS\_CONTR Register (0x81)

The PS\_CONTR register controls the PS operation modes. The PS sensor can be set to either standby mode or active mode. At either of these modes, the I2C circuitry is always active. The default mode after power up is standby mode. During standby mode, there is no ALS measurement performed but I2C communication is allowed to enable read/write to all the registers.

0x81	PS_CONTR (default = 0x0C)							
	Bit 7	Bit 6	Bit 5	Bit 4	Bit 3	Bit 2	Bit 1	Bit 0
	<i>Reserved</i>				<i>PS Gain</i>		<i>PS Mode</i>	<i>Reserved</i>

Field	BITS	Description
Reserved	7:4	Must write as 0
PS Gain	3:2	Must write as 11
PS Mode	1	



## 6.6. ALS\_MEAS\_RATE Register (0x85)

Field	BITS	Description
Part Number ID	7:4	0x09H
Revision ID	3:0	0x01H

## 6.8. MANUFAC\_ID Register (0x87) (Read Only)

The MANUFAC\_ID register defines the manufacturer identification of the sensor.

0x87	MANUFAC_ID (default = 0x05)							
	Bit 7	Bit 6	Bit 5	Bit 4	Bit 3	Bit 2	Bit 1	Bit 0
	<i>Manufacturer ID</i>							

Field	BITS	Description
Manufacturer ID	7:0	0x05H

## 6.9. ALS\_DATA Register (0x88 / 0x89) (Read Only)

The final ALS converted lux data are expressed as a 16-bit data spread over two registers. The ALS\_DATA\_0 and ALS\_DATA\_1 registers provide the lower and upper byte respectively. This 16-bit data equals to illuminance in lux. When the I2C read operation starts, both the registers are locked until the I2C read operation is completed. This will ensure that the data in the registers is from the same measurement even if an additional integration cycle ends during the read operation. New measurement data is stored into temporary registers and the ALS\_DATA registers are updated as soon as there is no on-going I2C read operation.

0x88	ALS_DATA_0 (default = 0x00)							
	Bit 7	Bit 6	Bit 5	Bit 4	Bit 3	Bit 2	Bit 1	Bit 0
	<i>LS Data Low</i>							

0x89	ALS_DATA_1 (default = 0x00)							
	Bit 7	Bit 6	Bit 5	Bit 4	Bit 3	Bit 2	Bit 1	Bit 0
	<i>LS Data High</i>							

# LIGHT

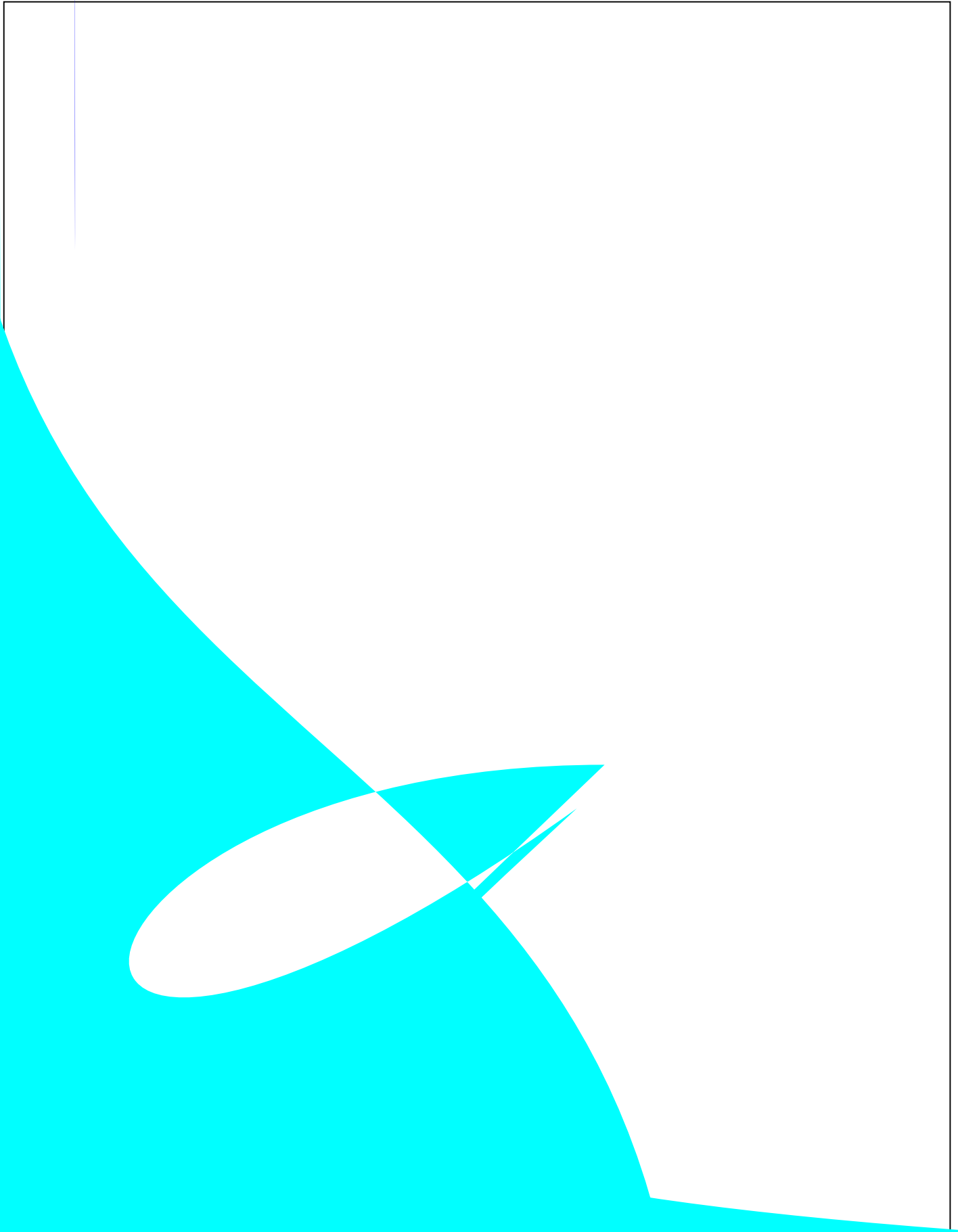



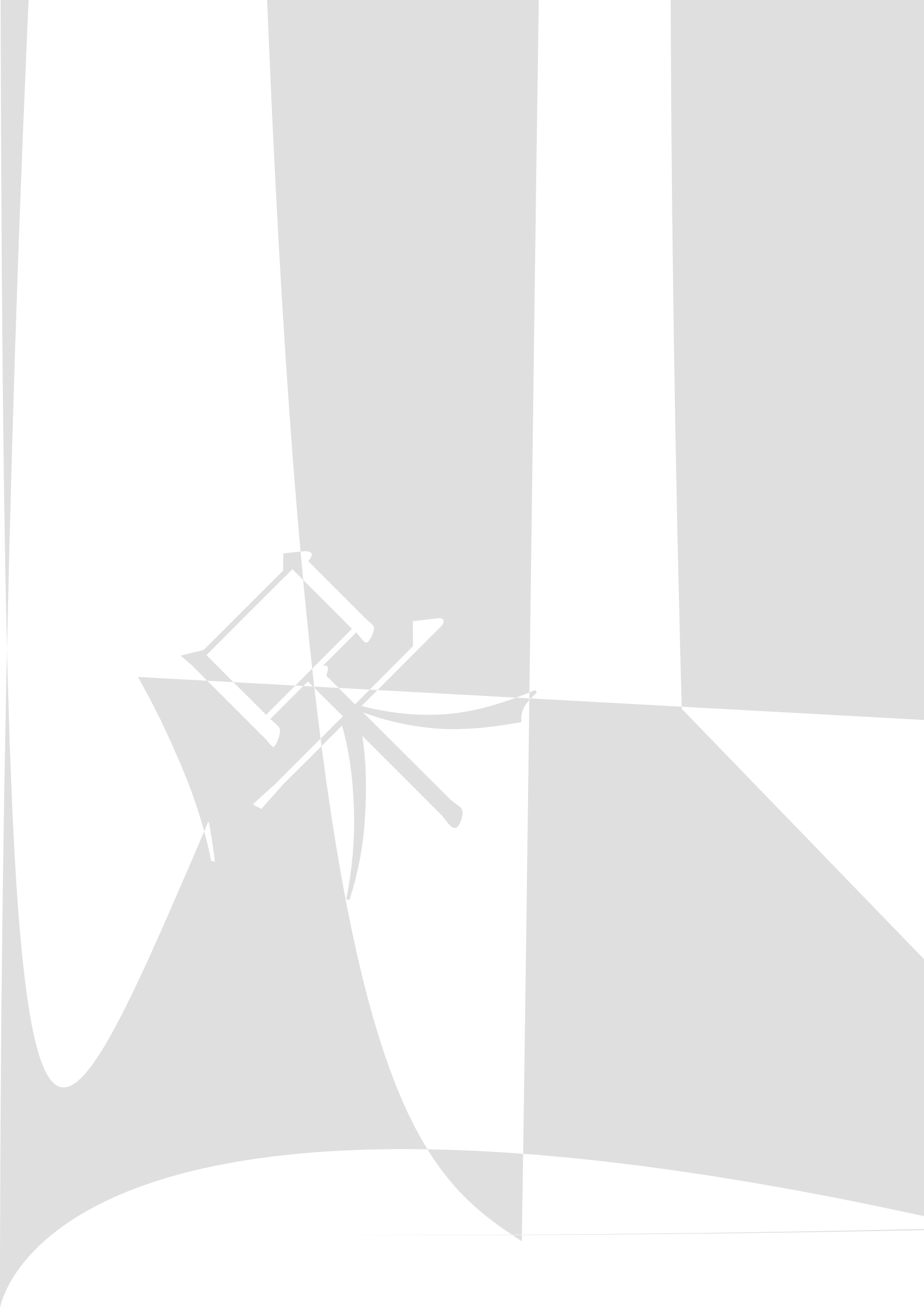



0x92	ALS_DATA_CH2_2 (default = 0x00)							
	Bit 7	Bit 6	Bit 5	Bit 4	Bit 3	Bit 2	Bit 1	Bit 0
	<i>ALS Data Ch2_2</i>							

Field	Addr	BITS	Description
ALS Data Ch2_0	0x90	7:4	ALS ADC channel 2 data least significant data byte, bit 4 is the LSB of the 20-bit data
ALS Data Ch2_0	0x90	3:0	Do not care
ALS Data Ch2_1	0x91	7:0	ALS ADC channel 2 data mid significant data byte
ALS Data Ch2_2	0x92	7:0	ALS ADC channel 2 data most significant data byte, bit 7 is MSB of the 20-bit data

#### 6.14. ALS\_COEFF1 Register (0x93 / 0x94)

The ALS\_COEFF1 is the 16-bit coefficient for the Ch1 diode to calculate the illuminance in lux. When the I2C read operation starts, both the registers are locked until the I2C read operation is completed. This will ensure that the data in the registers is from the same measurement even if an additional integration cycle ends during the read operation. New measurement data is stored into temporary registers and the ALS\_COEFF1 registers are updated as soon as there is no on-going I2C read operation.

0x93	ALS_COEFF1_0 (default = 0x80)							
	Bit 7	Bit 6	Bit 5	Bit 4	Bit 3	Bit 2	Bit 1	Bit 0
	<i>ALS Coeff1_0</i>							

0x94	ALS_COEFF1_1 (default = 0x03)							
	Bit 7	Bit 6	Bit 5	Bit 4	Bit 3	Bit 2	Bit 1	Bit 0
	<i>ALS Coeff1_1</i>							

Field	Addr	BITS	Description
ALS COEFF1_0	0x93	7:0	ALS coefficient 1 data least significant data byte, bit 0 is the LSB of the 16-bit data
ALS COEFF1_1	0x94	7:0	ALS coefficient 1 data most significant data byte, bit 7 is MSB of the 16-bit data

## 6.15. ALS\_COEFF2 Register (0x95 / 0x96)

The ALS\_COEFF2 is the 16-bit coefficient for the Ch2 diode to calculate the illuminance in lux. These coefficients are programmable to be optimized for different input filters and light spectra. When the I2C read operation starts, both the registers are locked until the I2C read operation is completed. This will ensure that the data in the registers is from the same measurement even if an additional integration cycle ends during the read operation. New measurement data is stored into temporary registers and the ALS\_COEFF2 registers are updated as soon as there is no on-going I2C read operation.

0x95	ALS_COEFF2_0 (default = 0xC8)							
	Bit 7	Bit 6	Bit 5	Bit 4	Bit 3	Bit 2	Bit 1	Bit 0
	<i>ALS Coeff2_0</i>							

0x96	ALS_COEFF2_1 (default = 0xFB)							
	Bit 7	Bit 6	Bit 5	Bit 4	Bit 3	Bit 2	Bit 1	Bit 0
	<i>ALS Coeff2_1</i>							

Field	Addr	BITS	Description
ALS COEFF2_0	0x95	7:0	ALS coefficient 2 data least significant data byte, bit 0 is the LSB of the 16-bit data
ALS COEFF2_1	0x96	7:0	ALS coefficient 2 data most significant data byte, bit 7 is MSB of the 16-bit data

## 6.16. ALS\_IRF\_CUT\_OFF Register (0x97)

The ALS\_IRF\_CUT\_OFF is the ALS cut off limit of IR factor. When the IR factor exceeds the cut-off limit, the output

0x97	ALS_IRF_CUT_OFF (default = 0xD0)							
	Bit 7	Bit 6	Bit 5	Bit 4	Bit 3	Bit 2	Bit 1	Bit 0
	<i>ALS IRF Cut Off</i>							

Field	Addr	BITS	Description
ALS IRF Cut Off	0x97	7:0	If ADCIR / ADCCLEAR > ALS IRF Cut Off, ALS_DATA = 0

## 6.17. INTERRUPT Register (0x98)

The INTERRUPT register controls the operation of the interrupt pin and functions. When the Interrupt Mode is set to 00, the INT output pin 2 is inactive / disabled and will not trigger any interrupt. However at this condition, the ALS\_PS\_STATUS register will still be updated.

0x98	INTERRUPT (default = 0x08)								
	Bit 7	Bit 6	Bit 5	Bit 4	Bit 3	Bit 2	Bit 1	Bit 0	
	<i>Reserved</i>				<i>Output Mode</i>	<i>Interrupt Polarity</i>	<i>Interrupt Mode</i>		

Field	BITS	Description
Reserved	7:4	Must write as 0
Output Mode	3	0: INT output pin 2 is latched and kept in triggered state until ALS_PS_STATUS register is read 1: INT output pin 2 is updated after every measurement (default)
Interrupt Polarity	2	0: INT output pin 2 is considered active when it is a logic 0 (default) 1: INT output pin 2 is considered active when it is a logic 1
Interrupt Mode	1:0	00: INT output pin 2 is inactive / high impedance state (default) 01: Only PS measurement can trigger interrupt 10: Only ALS measurement can trigger interrupt 11: Both ALS and PS measurement can trigger interrupt

## 6.18. PS\_THRES Register (0x99 / 0x9A / 0x9B / 0x9C)

The PS\_THRES\_UP and PS\_THRES\_LOW registers determines the upper and lower limit of the interrupt threshold value respectively. These two values form a range and the interrupt function compares if the measurement value in PS\_DATA registers is inside or outside the range. The interrupt function is active if the measurement data is outside the range defined by the upper and lower limits. The data format for PS\_THRES must be the same as PS\_DATA registers.

0x99	PS_THRES_UP_0 (default = 0xFF)							
	Bit 7	Bit 6	Bit 5	Bit 4	Bit 3	Bit 2	Bit 1	Bit 0
	<i>PS Upper Threshold Low</i>							

0x9A	PS_THRES_UP_1 (default = 0x07)							
	Bit 7	Bit 6	Bit 5	Bit 4	Bit 3	Bit 2	Bit 1	Bit 0
	Reserved					PS Upper Threshold High		

**PS\_THRES\_LOW** is a 16-bit lower threshold limits made up of two 8 bits register as shown below.

0x9B	PS_THRES_LOW_0 (default = 0x00)							
	Bit 7	Bit 6	Bit 5	Bit 4	Bit 3	Bit 2	Bit 1	Bit 0
	PS Lower Threshold Low							

0x9C	PS_THRES_LOW_1 (default = 0x00)							
	Bit 7	Bit 6	Bit 5	Bit 4	Bit 3	Bit 2	Bit 1	Bit 0
	Reserved					PS Lower Threshold High		

Field	Addr	BITS	Description
PS Upper Threshold Low	0x99	7:0	PS upper threshold lower byte
Reserved	0x9A	7:3	Do not care
PS Upper Threshold High	0x9A	2:0	PS upper threshold upper byte
PS Lower Threshold Low	0x9B	7:0	PS lower threshold lower byte
Reserved	0x9C	7:3	Do not care
PS Lower Threshold High	0x9C	2:0	PS lower threshold upper byte

### 6.19. ALS\_THRES Register (0x9E / 0x9F / 0xA0 / 0xA1)

The ALS\_THRES\_UP and ALS\_THRES\_LOW registers determines the upper and lower limit of the interrupt threshold value respectively. These two values form a range and the interrupt function compares if the measurement value in ALS\_DATA registers is inside or outside the range. The interrupt function is active if the measurement data is outside the range defined by the upper and lower limits. The data format for ALS\_THRES must be the same as ALS\_DATA registers.



0xA4	INTERRUPT PERSIST (default = 0x00)							
	Bit 7	Bit 6	Bit 5	Bit 4	Bit 3	Bit 2	Bit 1	Bit 0
	<i>PS Persist</i>				<i>ALS Persist</i>			

Field	BITS	Description
PS Persist	7:4	0000: Every PS measurement data will generate an interrupt (default) 0001: 1 consecutive PS measurement data outside the range 0010: 2 consecutive PS measurement data outside the range  1111: 15 consecutive PS measurement data outside the range
ALS Persist	3:0	0000: Every ALS measurement data will generate an interrupt (default) 0001: 1 consecutive ALS measurement data outside the range 0010: 2 consecutive ALS measurement data outside the range  1111: 15 consecutive ALS measurement data outside the range



// For Meas rate = 1000ms, Command = 0x06  
// For Meas rate = 2000ms, Command = 0x07





```

// For PS persist = 0, Command = 0x00
// For PS persist = 1, Command = 0x10
// For PS persist = 2, Command = 0x20

// For PS persist = 15, Command = 0xF0

WriteByte(Slave_Addr, Register_Addr, Command)

// Set ALS Persist 5 (with PS persist 0)
Register_Addr = 0xA4
Command = 0x05

// INTERRUPT PERSIST register
// ALS persist = 5
// For ALS persist = 0, Command = 0x00
// For ALS persist = 1, Command = 0x01
// For ALS persist = 2, Command = 0x02

// For ALS persist = 15, Command = 0x0F

WriteByte(Slave_Addr, Register_Addr, Command)

```

## Control Registers

```

// The Control Registers define the operating modes and gain settings of the ALS and PS of LT-507.
// It is recommended that Control Register for ALS (0x80) and PS (0x81) to be set at the end of the sequence.
// This is to ensure all register settings are the same for all started measurement.
// Default settings are 0x00 for ALS register and 0x0C for PS register (both in Standby mode after power up).

```

```

Slave_Addr = 0x23 // Slave address of LT-507 device

// Enable ALS
Register_Addr = 0x80 // ALS_CONTR register
Command = 0x02 // For Dynamic Range 1 (1 to 64klux)
// For Dynamic Range 2 (0.5 to 32klux), Command = 0x05
// For Dynamic Range 3 (0.02 to 640lux), Command = 0x10
// For Dynamic Range 4 (0.01 to 320lux), Command = 0x18

WriteByte(Slave_Addr, Register_Addr, Command)

// Enable PS
Register_Addr = 0x81 // PS_CONTR register
Command = 0x0E

WriteByte(Slave_Addr, Register_Addr, Command)

```

## Data Registers (Read Only)

```

// The ALS and PS Data Registers contain the ADC output data.
// These registers should be read as a group, with the lower address being read first.

```

```

Slave_Addr = 0x23 // Slave address of LT-507 device

// Read ALS_DATA
Register_Addr = 0x88 // ALS ADC low byte address
ReadByte(Slave_Addr, Register_Addr, Data0)
Register_Addr = 0x89 // ALS ADC high byte address
ReadByte(Slave_Addr, Register_Addr, Data1)

ALS_ADC_Data = (Data1 << 8) | Data0 // Combining lower and upper bytes to give 16-bit ALS ADC data
(Direct conversion to illuminance in lux).

Slave_Addr = 0x23 // Slave address of LT-507 device

// Read PS_DATA
Register_Addr = 0x8B // PS_DATA low byte address
ReadByte(Slave_Addr, Register_Addr, Data0)
Register_Addr = 0x8C // PS_DATA high byte address
ReadByte(Slave_Addr, Register_Addr, Data1)

```

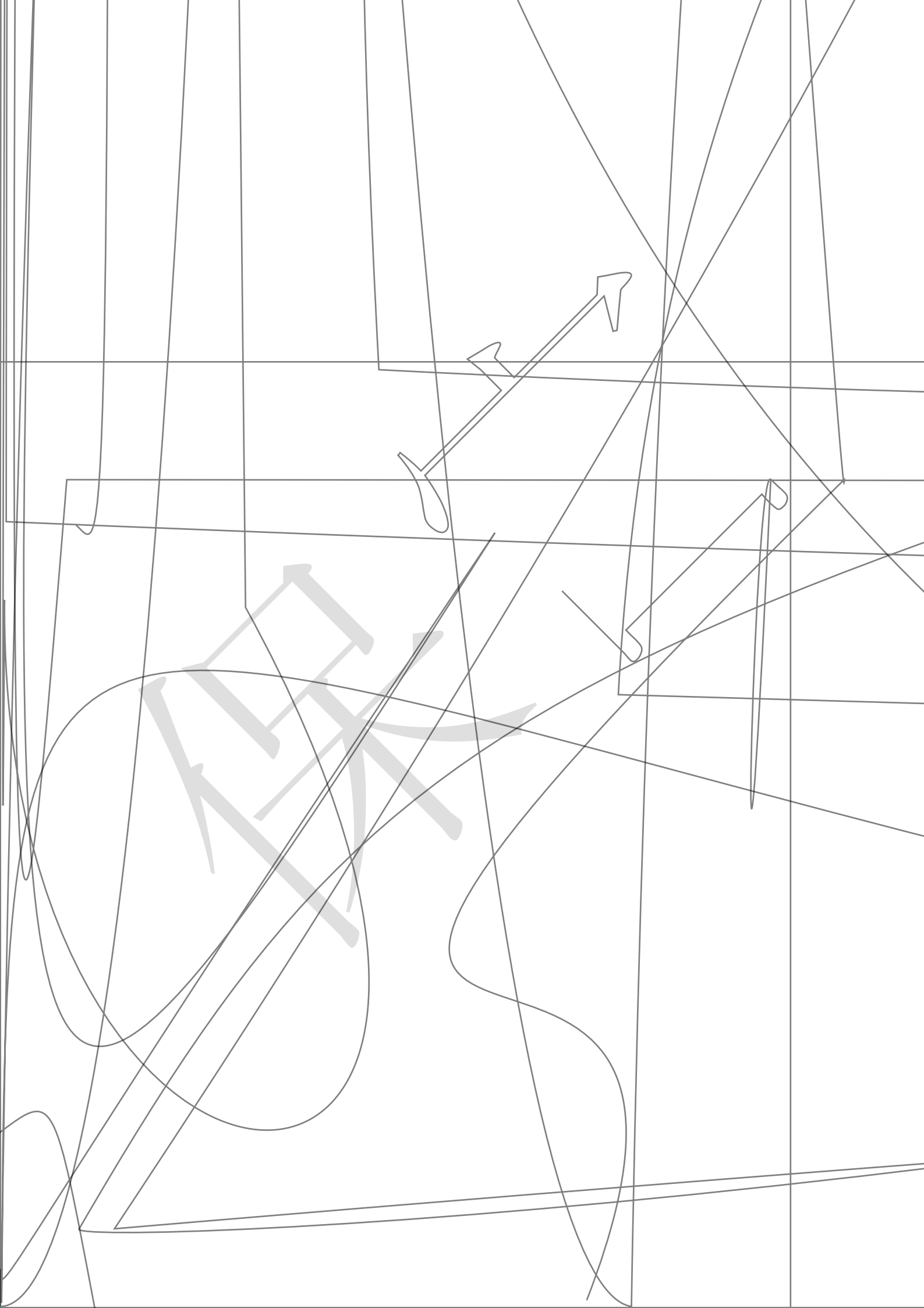

## 8. Recommended Lead-free Reflow Profile

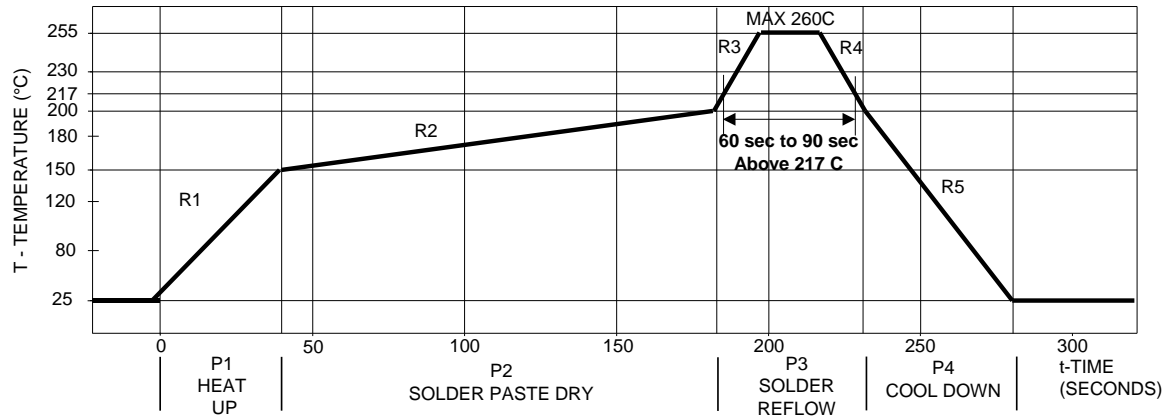

Process Zone	Symbol	$\Delta T$	Maximum $\Delta T/\Delta \text{time}$ or Duration
Heat Up	P1, R1	25°C to 150°C	3°C/s
Solder Paste Dry	P2, R2	150°C to 200°C	100s to 180s
Solder Reflow	P3, R3	200°C to 260°C	3°C/s
	P3, R4	260°C to 200°C	-6°C/s
Cool Down	P4, R5	200°C to 25°C	-6°C/s
Time maintained above liquidus point , 217°C		> 217°C	60s to 90s
Peak Temperature		260°C	-
Time within 5°C of actual Peak Temperature		> 255°C	20s
Time 25°C to Peak Temperature		25°C to 260°C	8mins

It is recommended to perform reflow soldering no more than twice.



## 10. Recommended Land Pattern and Metal Stencil Aperture

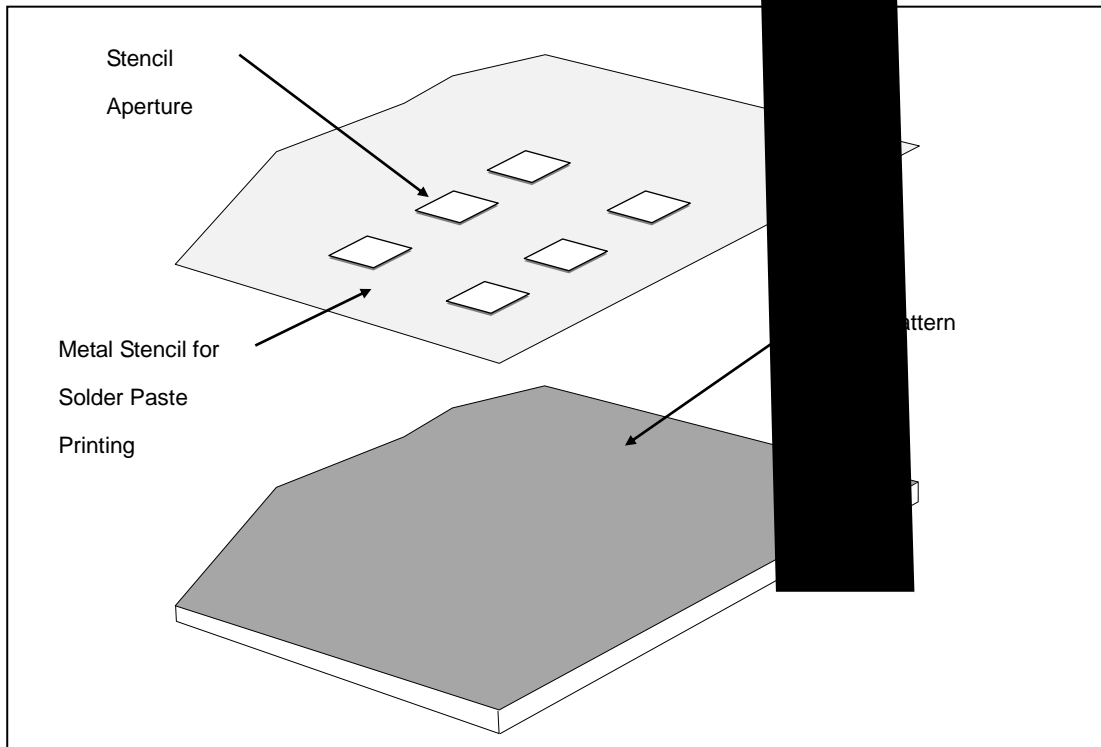

### 10.1 Recommended Land Pattern

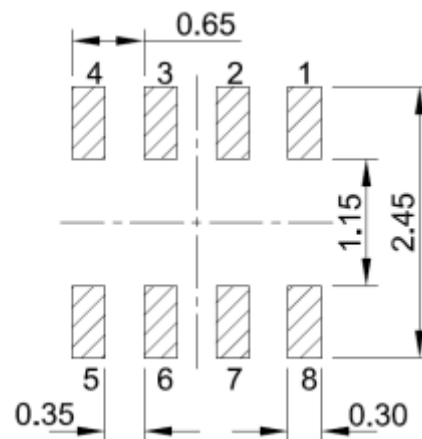

**Note:**

1. All dimensions are in millimeters



