

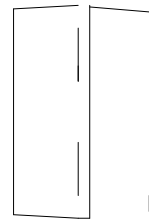

## Features

- Pb free product—RoHS compliant
- Low power consumption, High efficiency
- Reliable and rugged
- Long life – solid state reliability
- Viewing angle: 120°

## Package Dimension

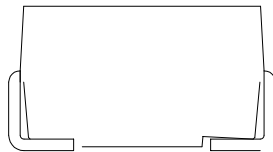

Part NO.	Lens Color	Source Color
SL-T3528IRURPC010-L180	Water Clear	Infrared/Red/Purple

### Notes:

1. All dimensions are in millimeters.
2. Tolerance is  $\pm 0.10$ mm unless otherwise noted.
3. Specifications are subject to change without notice.





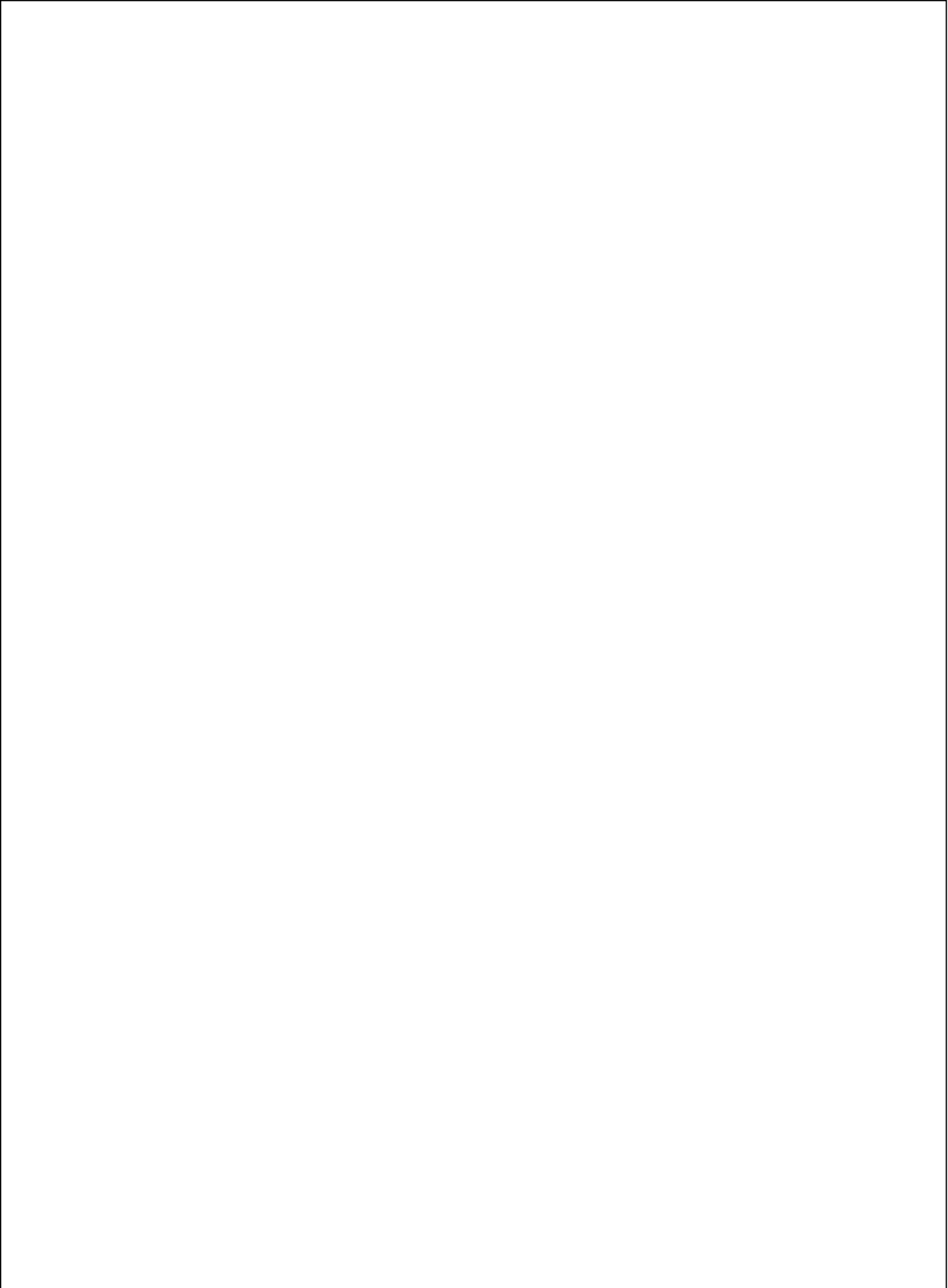

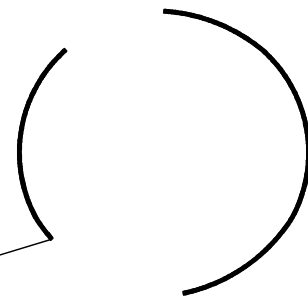
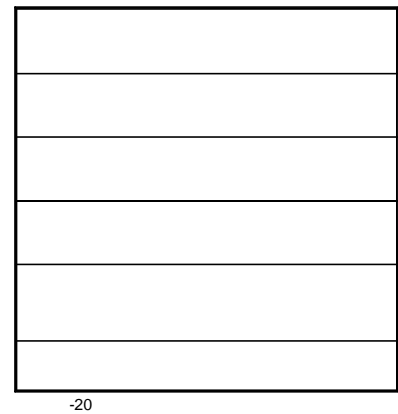
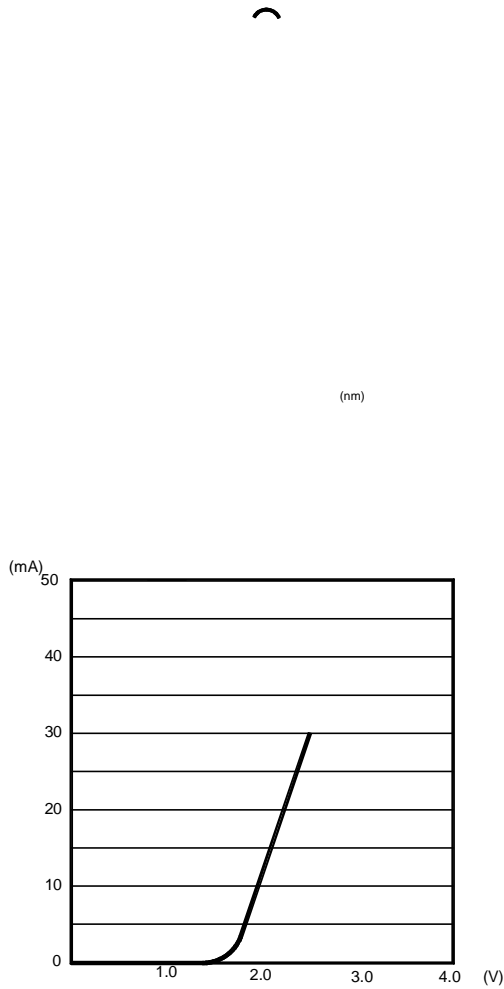

## Typical Electrical / Optical Characteristics Curves for Red (25°C Ambient Temperature Unless Otherwise Noted)

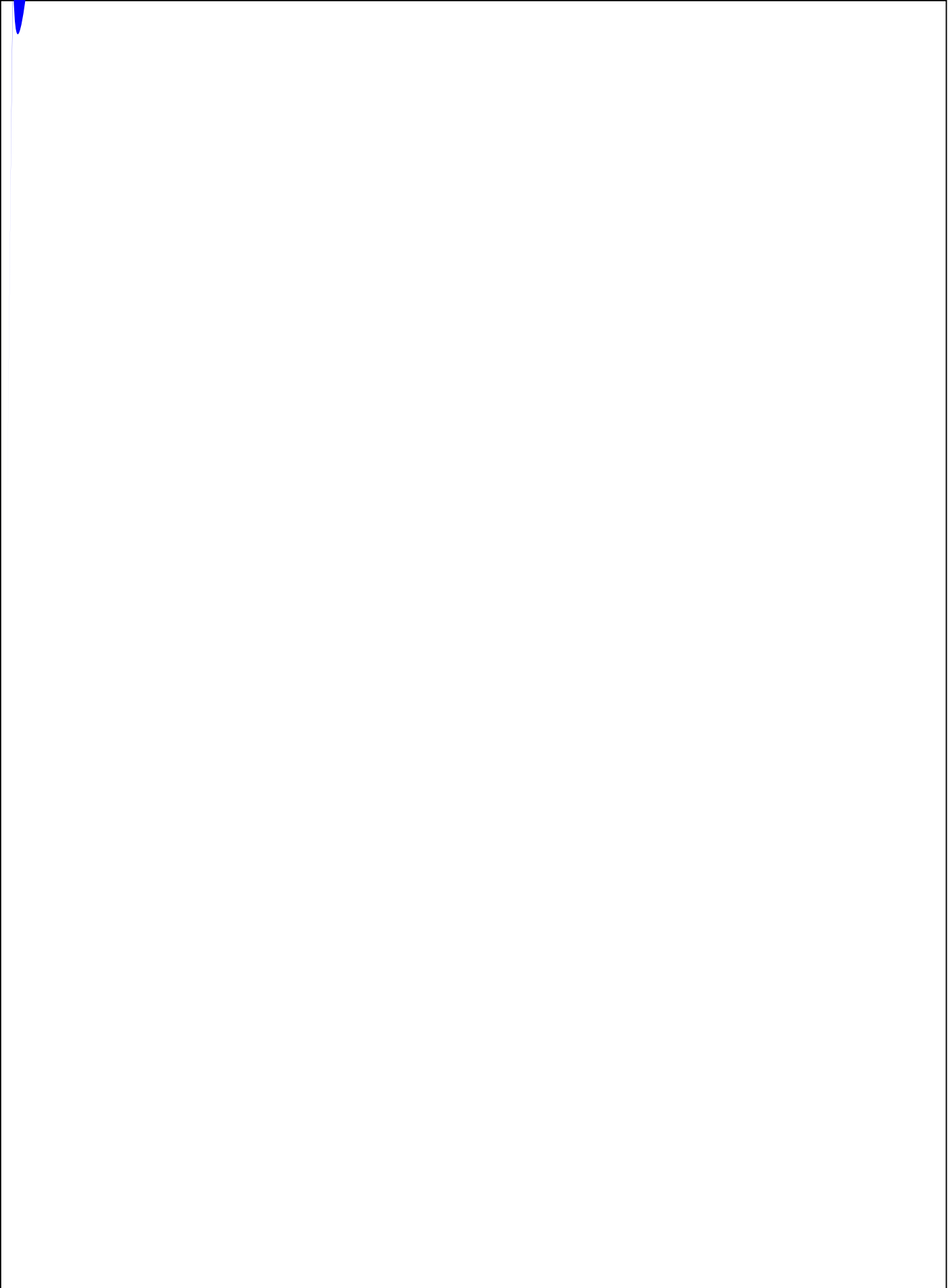



## Label Explanation

LIGHT Universal Label

<b>LIGHT</b>		<b>RoHS</b>
Light Electronics CO., LTD.		
MODEL NAME: _____	 LOT NO. : _____	
QUANTITY: _____		
BIN: _____		
PACKING DATE: _____		
REMARKS: _____		

Customer Defined Label

<b>LIGHT</b>		<b>RoHS</b>
Light Electronics CO., LTD.		
MODEL NAME: _____	 LOT NO. : _____	
QUANTITY: _____		
BIN: _____		
PACKING DATE: _____		
CUSTOMER P/N: _____		

## Reel Dimensions

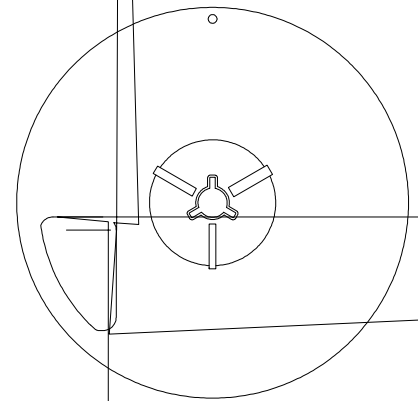
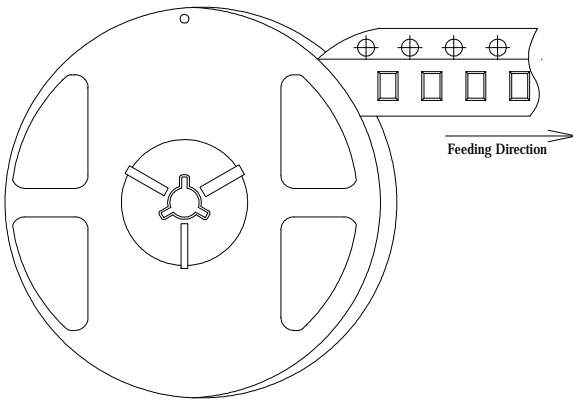

**Note:** Tolerance unless mentioned is  $\pm 0.2\text{mm}$ ; Unit = mm





