



P160

P160

600 V
 LED 10mA
 2500 Vrms

AC

● Schematic

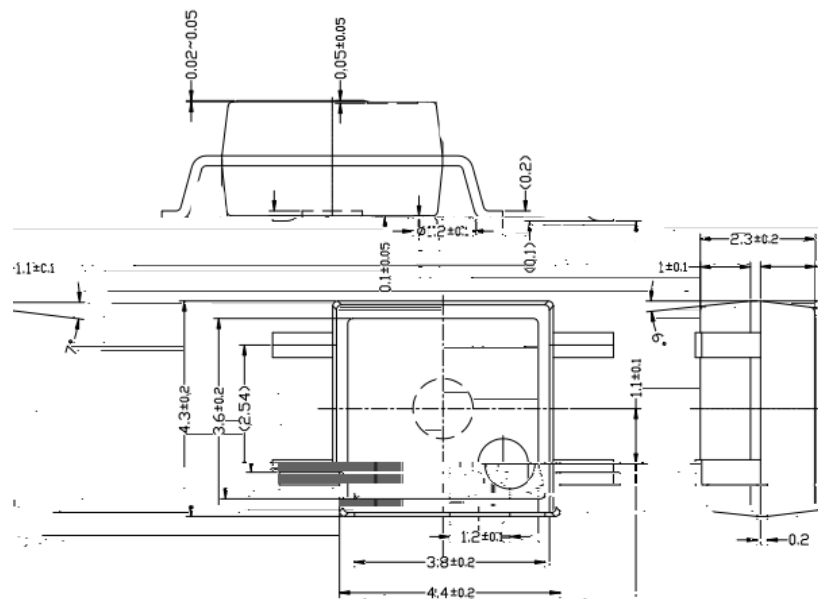
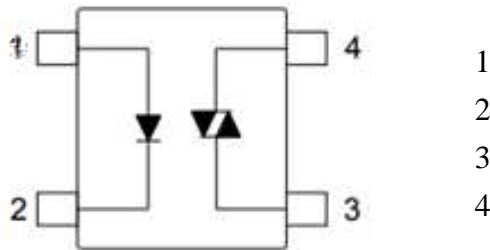

LED			IF	50	mA
			VR	5	V
			IFP	1	A
			IF/	-0.7	mA/
		VDRM		600	V
RMS	Ta=25		IT	70	mA
	Ta=70			40	
	Ta 25		IT/	-0.7	mA/
		Tstg		-40~150	
		Topr		-40~85	
		Tsol		260(10s)	
		PD/		-4.0	mW/
		BVS		2500(AC,	

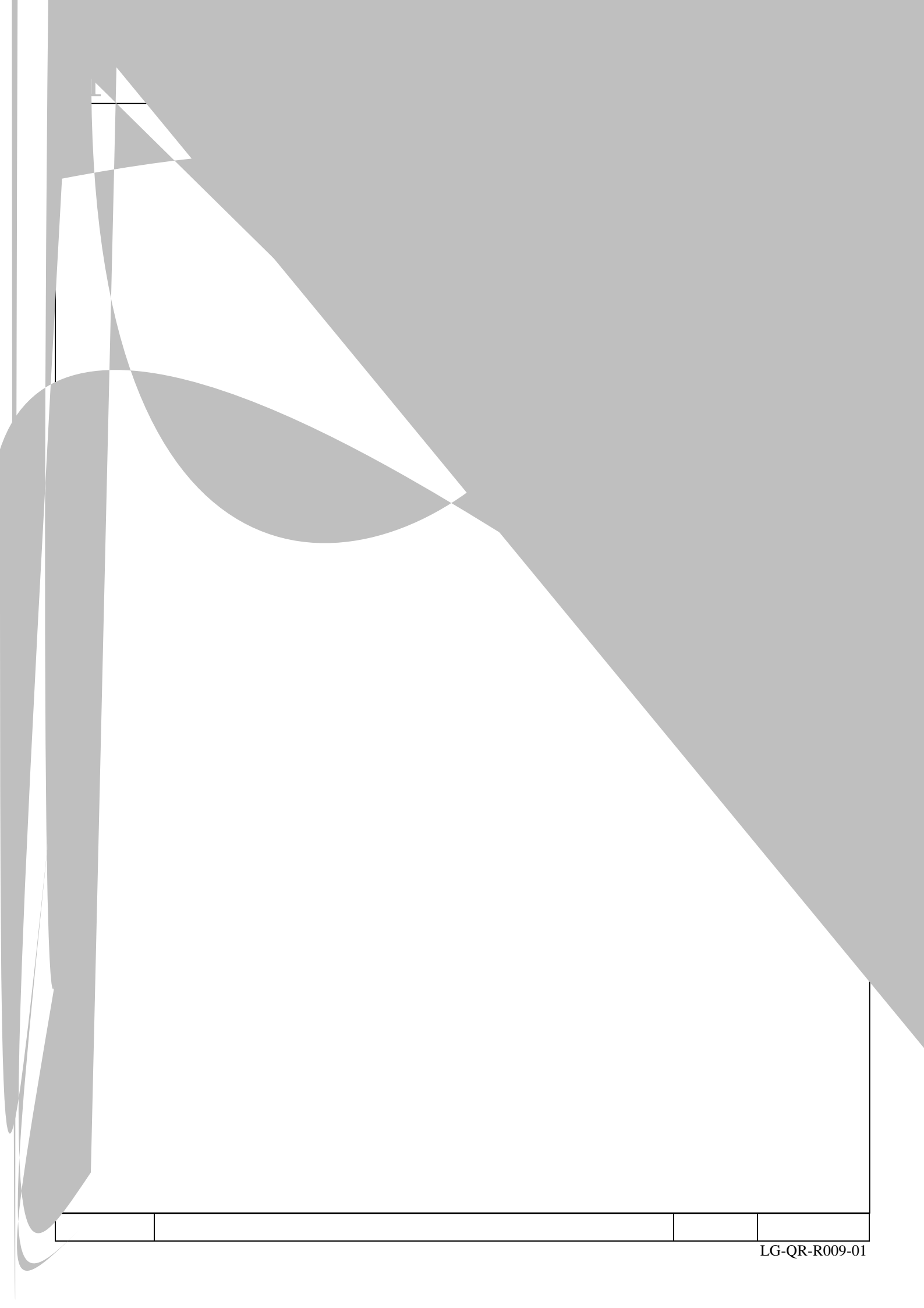

--	--	--	--

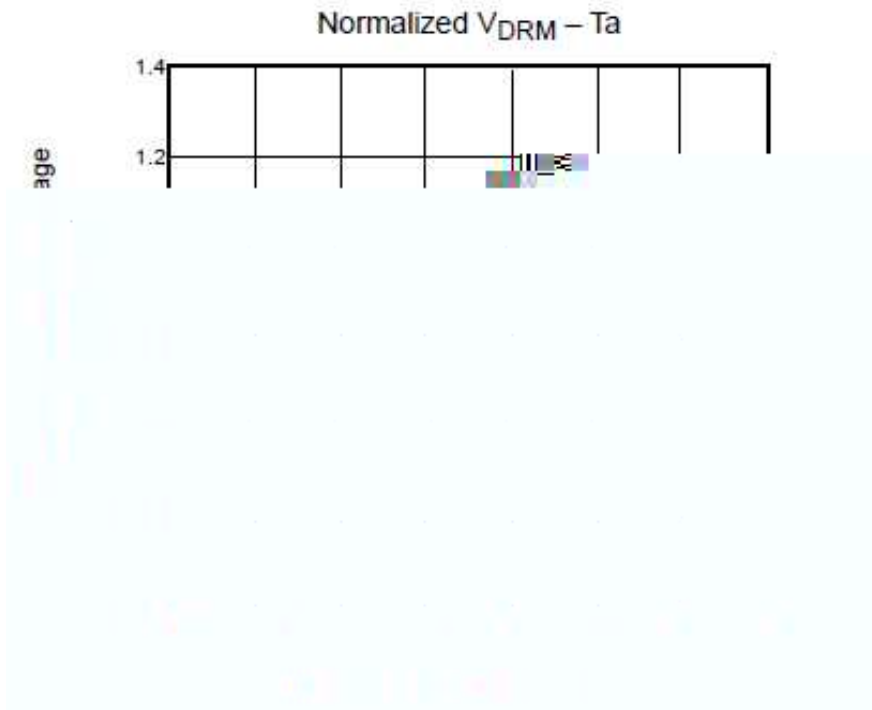
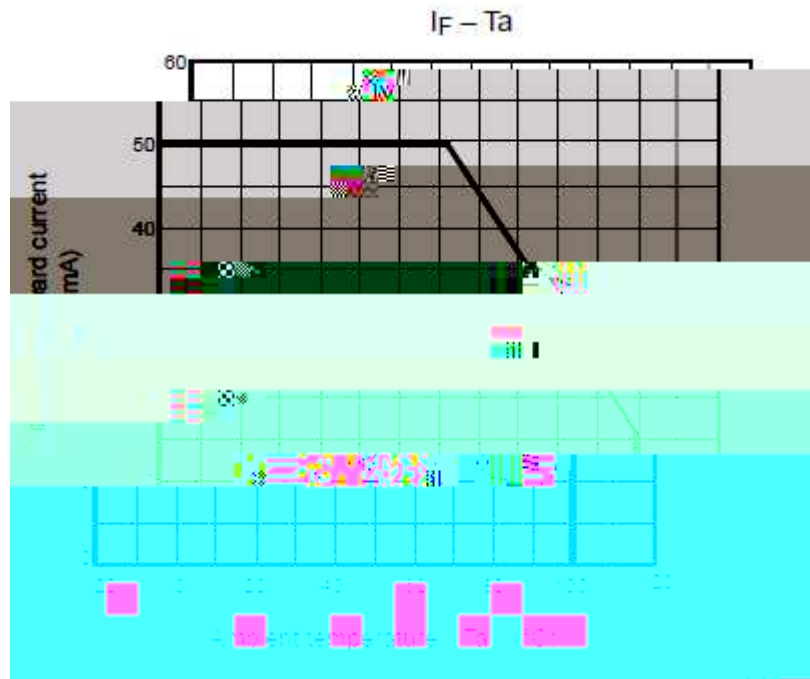

L

LIGHT ELECTRONICS CO., LTD.

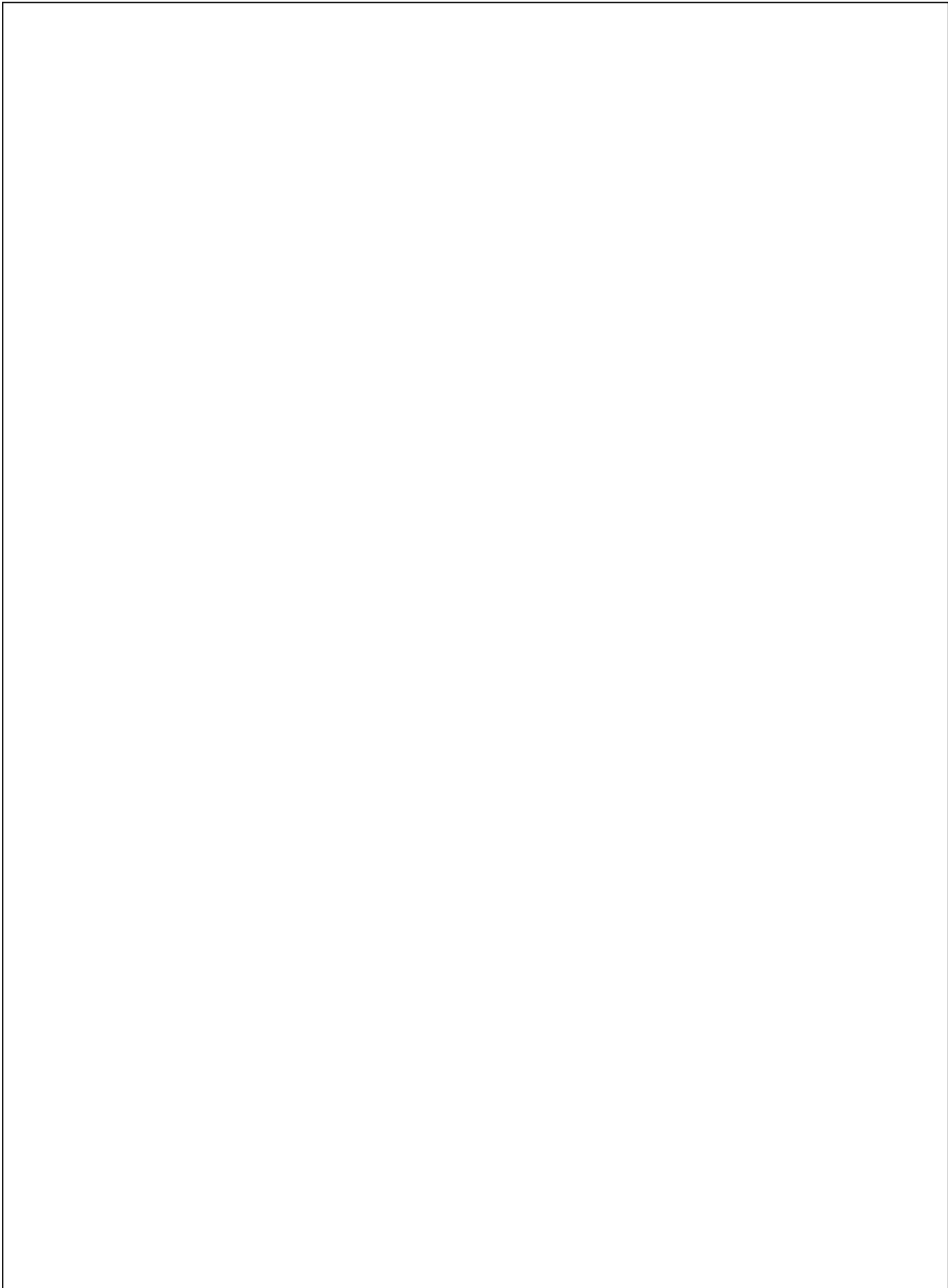

--	--	--	--

$I_{FP} - D_R$

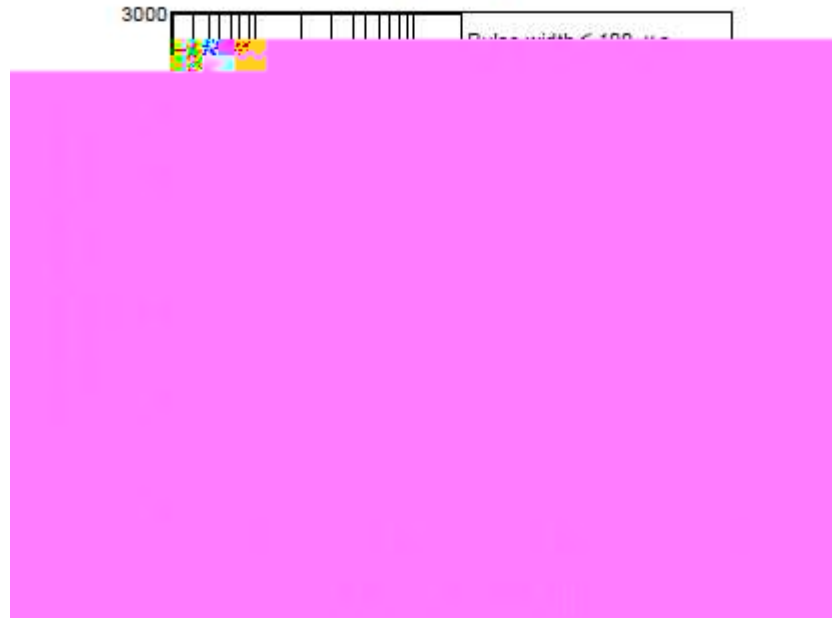

$\Delta V_F / \Delta T_a - I_F$

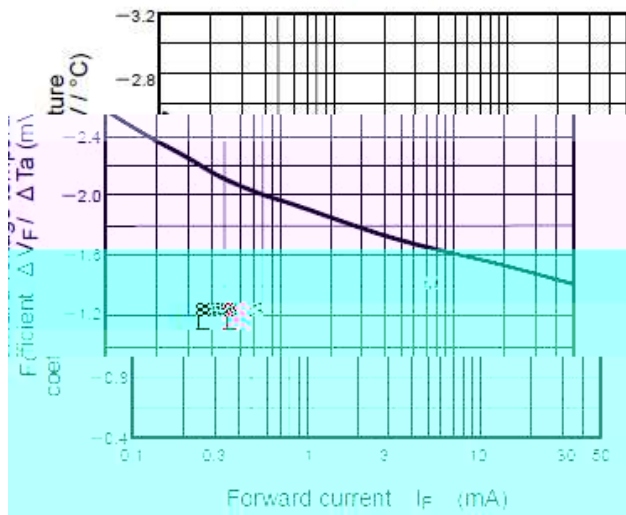

$I_{FP} - V_{FP}$

