



## Electrical Optical Characteristics at Ta=25°C

Parameter	Symbol	Color	Min.	Typ.	Max.	Unit	Test Condition
Radiant Intensity	I <sub>e</sub>	Infrared	2.5	4.0	5.8	mW/sr	I <sub>F</sub> =20mA
Luminous Intensity	I <sub>v</sub>	Red	200	275	415	mcd	I <sub>F</sub> =20mA
	$\theta_{1/2}$	---	---	120	---	Deg.	(Note 2)
Peak Emission Wavelength		Infrared	930	940	960	nm	I <sub>F</sub> =20mA
		Red	650	660	665	nm	I <sub>F</sub> =20mA
Spectral Line Half-Width		Infrared	---	50	---	nm	I <sub>F</sub> =20mA
		Red	---	20	---	nm	I <sub>F</sub> =20mA
Forward Voltage	V <sub>F</sub>	Infrared	1.1	---	1.5	V	I <sub>F</sub> =20mA
		Red	1.9	---	2.3	V	I <sub>F</sub> =20mA
Reverse Current	I <sub>R</sub>	---	---	---	10	μA	V <sub>R</sub> =5V

### Note:

1. Luminous intensity is measured with a light sensor and filter combination that approximates the CIE eye-response curve. Tolerance of Luminous Intensity: ±15%.
2.  $\theta_{1/2}$  is the off-axis angle at which the luminous intensity is half the axial luminous intensity.
- 3.



## Typical Electrical / Optical Characteristics Curves for Red (25°C Ambient Temperature Unless Otherwise Noted)

Fig.1 Spectral Distribution

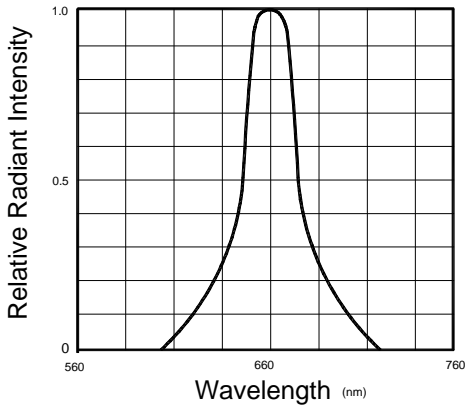

Fig.2 Forward Current Vs Ambient Temperature

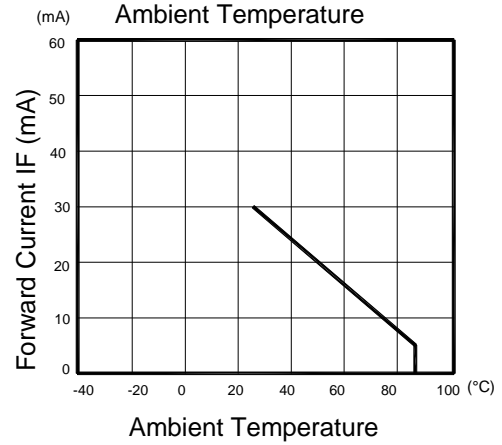

Fig.3 Forward Current Vs Forward Voltage

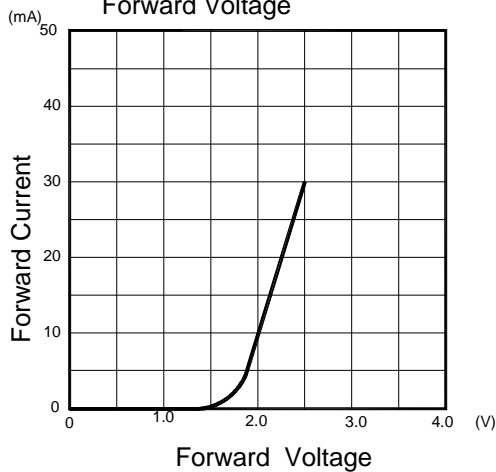

Fig.4 Relative Radiant Intensity Vs Ambient Temperature

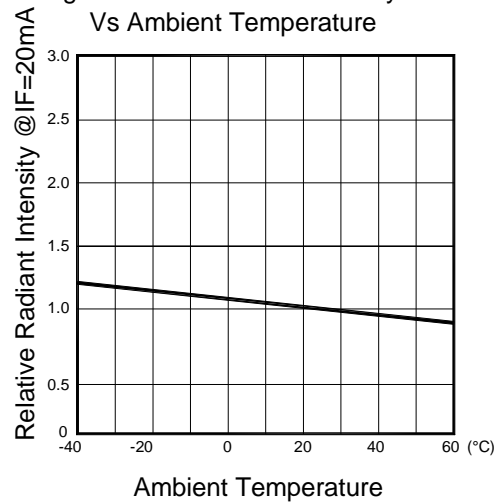

Fig.5 Relative Radiant Intensity Vs Forward Current

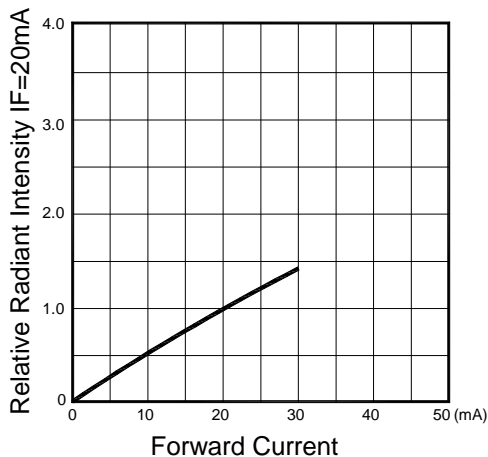
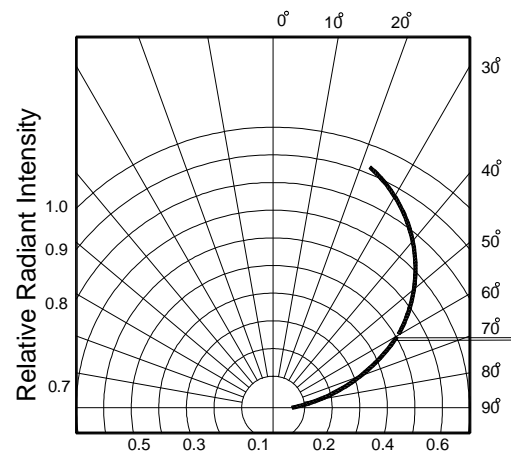



Fig.6 Radiation Diagram



## Label Explanation

LIGHT Universal Label

<b>LIGHT</b>		<b>RoHS</b>
Light Electronics CO., LTD.		
MODEL NAME: _____	 LOT NO. : _____	
QUANTITY: _____		
BIN: _____		
PACKING DATE: _____		
REMARKS: _____		

Customer Defined Label

<b>LIGHT</b>		<b>RoHS</b>
Light Electronics CO., LTD.		
MODEL NAME: _____	 LOT NO. : _____	
QUANTITY: _____		
BIN: _____		
PACKING DATE: _____		
CUSTOMER P/N: _____		

## Reel Dimensions

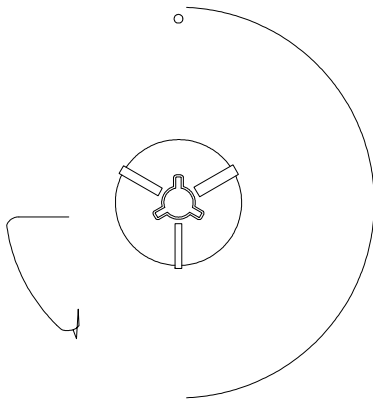

**Note:** Tolerance unless mentioned is  $\pm 0.2\text{mm}$ ; Unit = mm





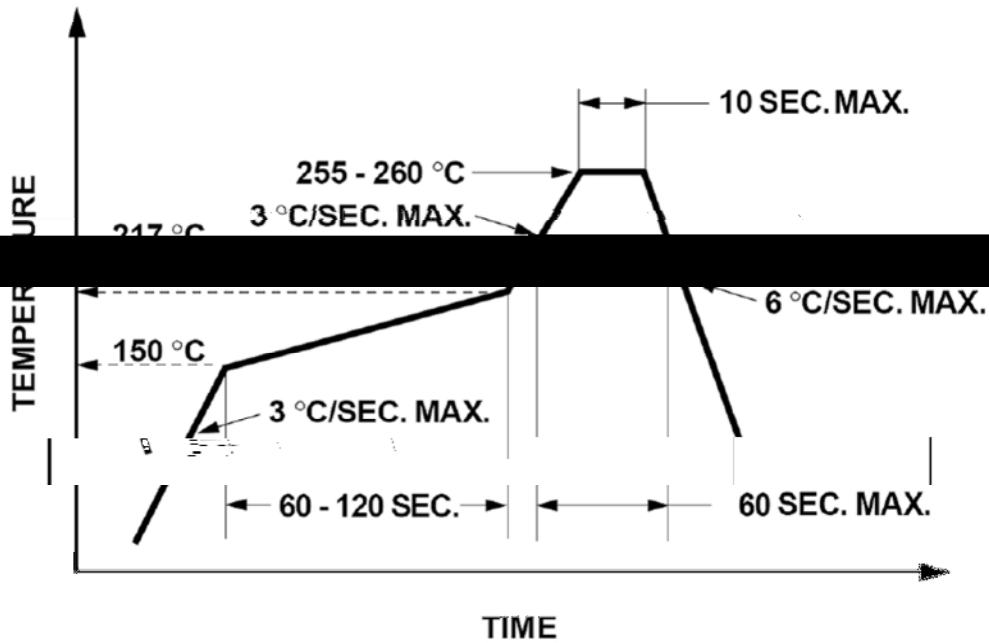

1. Reflow soldering should not be done more than two times.
2. When soldering, do not put stress on the LEDs during heating.

**Soldering iron**

1. When hand soldering, the temperature of the iron must less than 300°C for 3 seconds.
2. The hand solder should be done only once.

**Repairing**

~~Repair should not be done after the LEDs have been soldered. When repairing is unavoidable, a double-head soldering iron should be used (as below figure). It should be confirmed beforehand whether the characteristics of LEDs will or will not be damaged by repairing.~~

