

LIGH

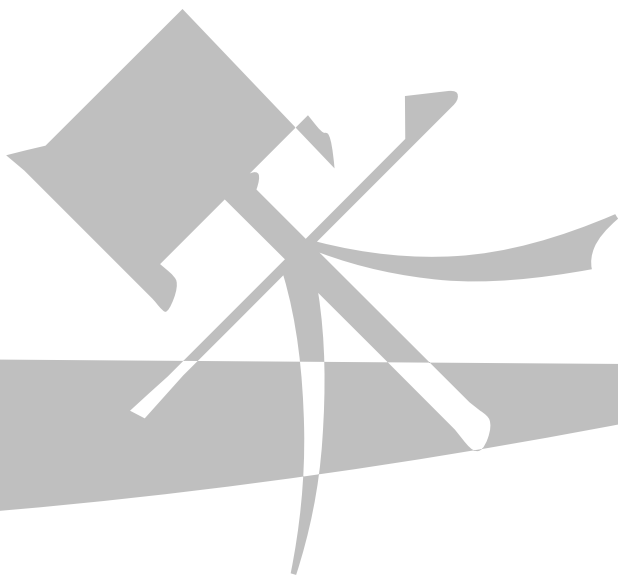

LI

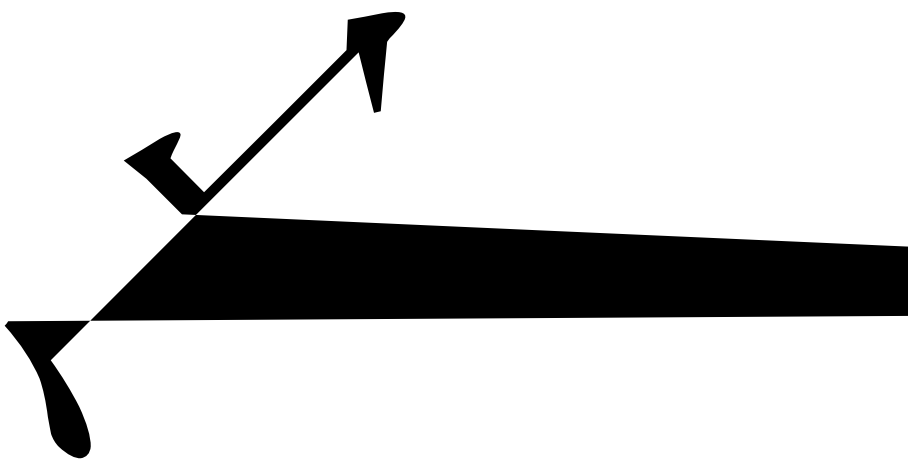

### Absolute Maximum Ratings at Ta=25

## Typical Electrical / Optical Characteristics Curves (25 Ambient Temperature Unless Otherwise Noted)



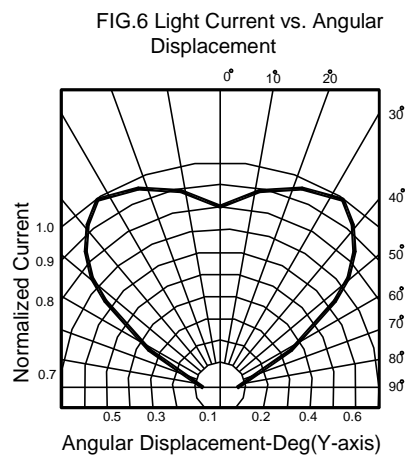
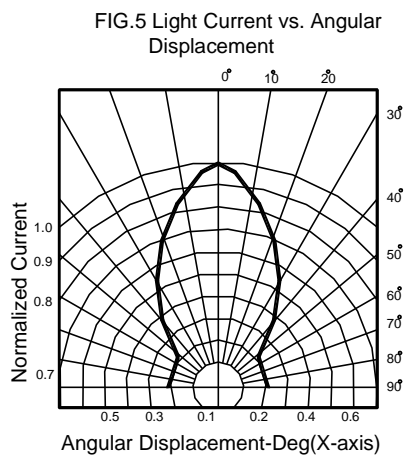
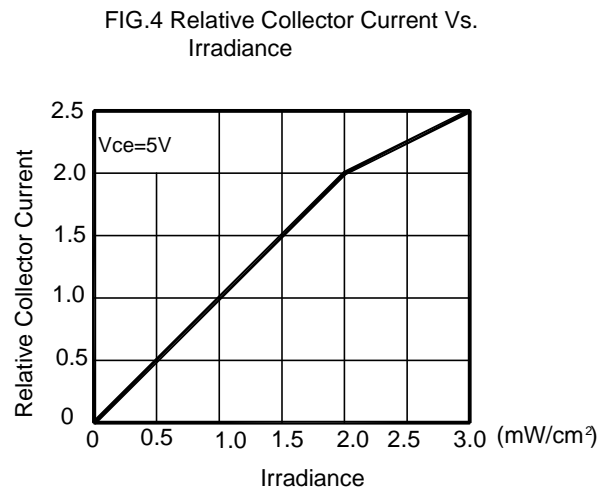
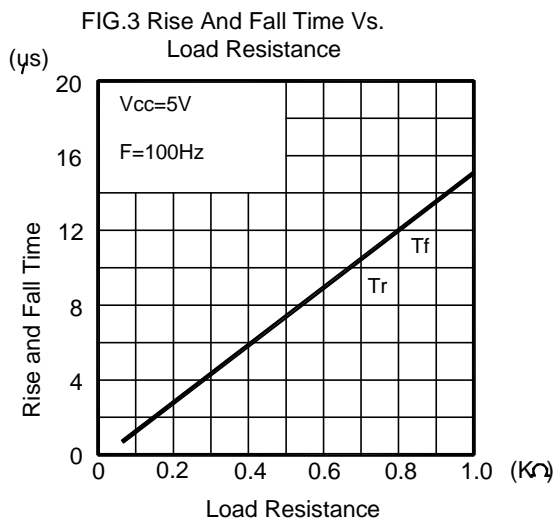
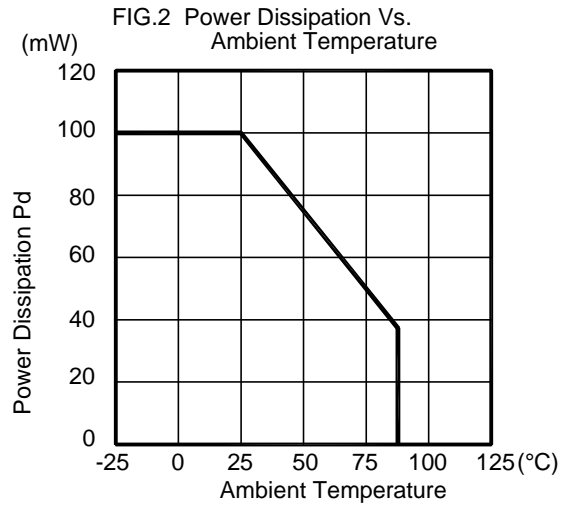
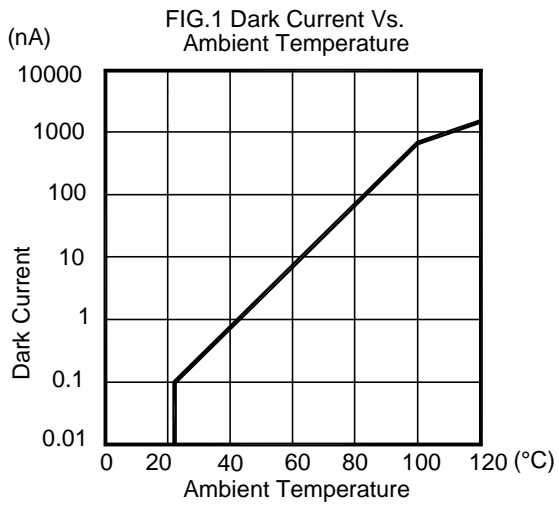

## Label Explanation

<b>LIGHT</b>	深圳莱特光电股份有限公司 Light Electronics CO., LTD.	
TYPE NO. :	_____	
QUANTITY :	_____	
BIN :	_____	
DATE CODE :	_____	
REMARKS :	_____	

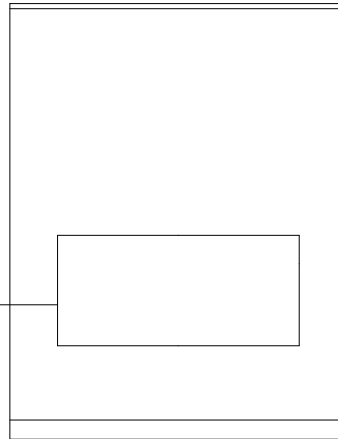

**Bag**

## Reel Dimensions

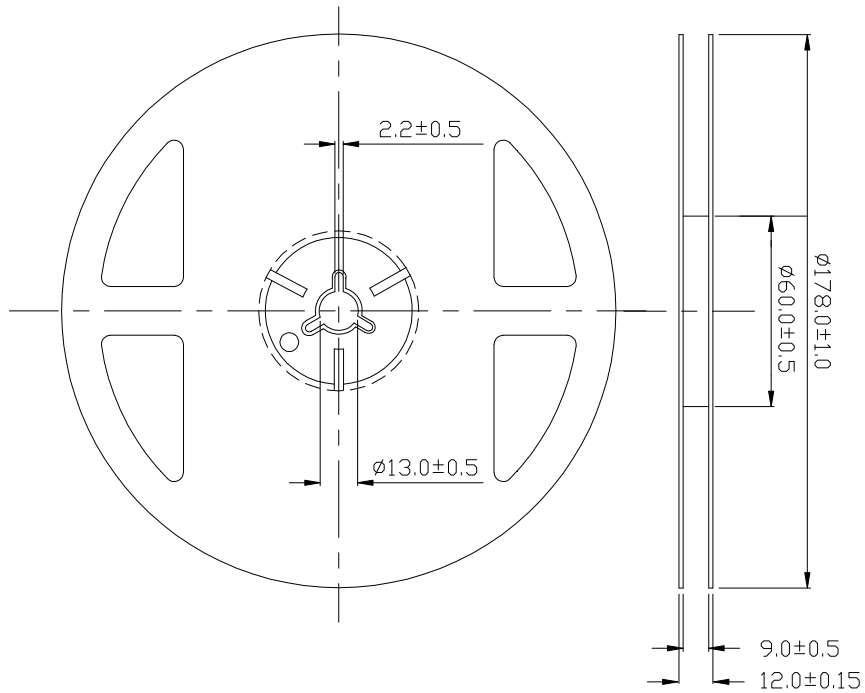

Note:





## Suggest IR Reflow Condition For Lead Free

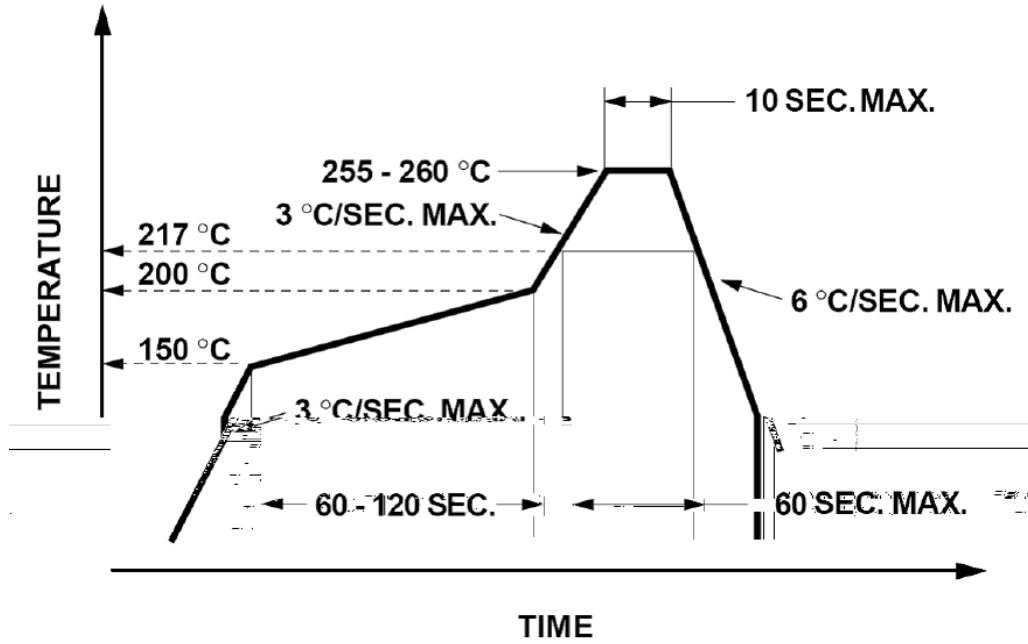

Soldering iron

°C

Repairing

