

--	--	--

LG-IRM2B238KSF3

IC

PIN

RoHS REACH

2.7-5.5V

TTL CMOS

(MP3 MP4,)

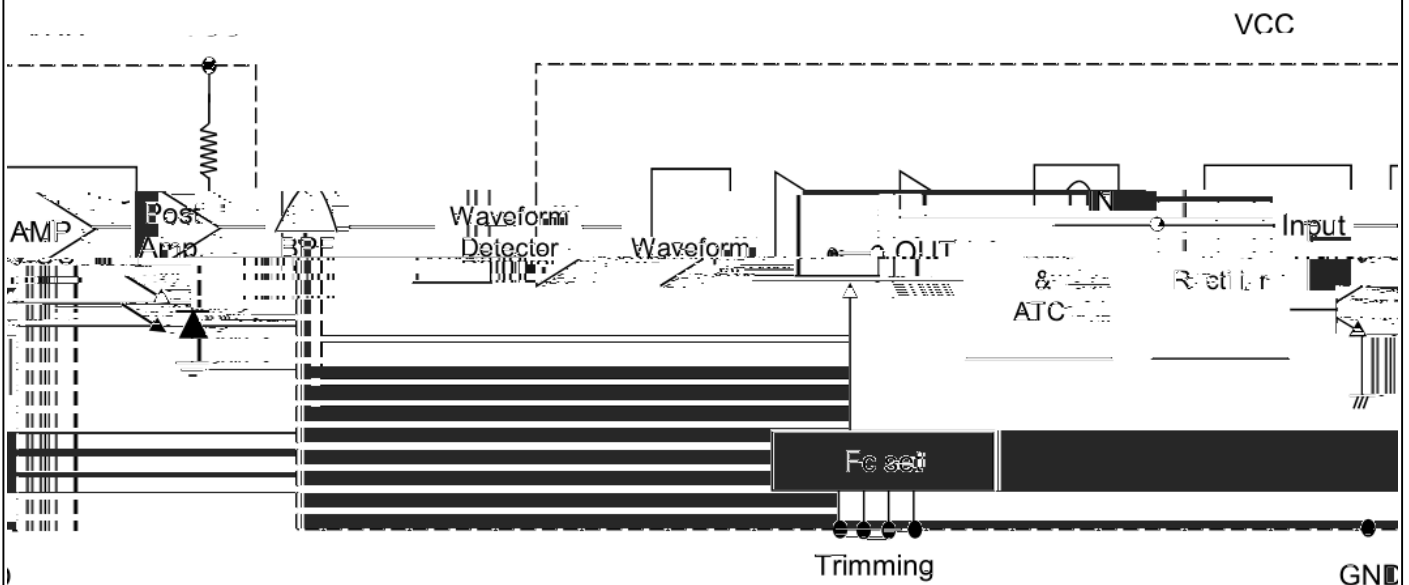
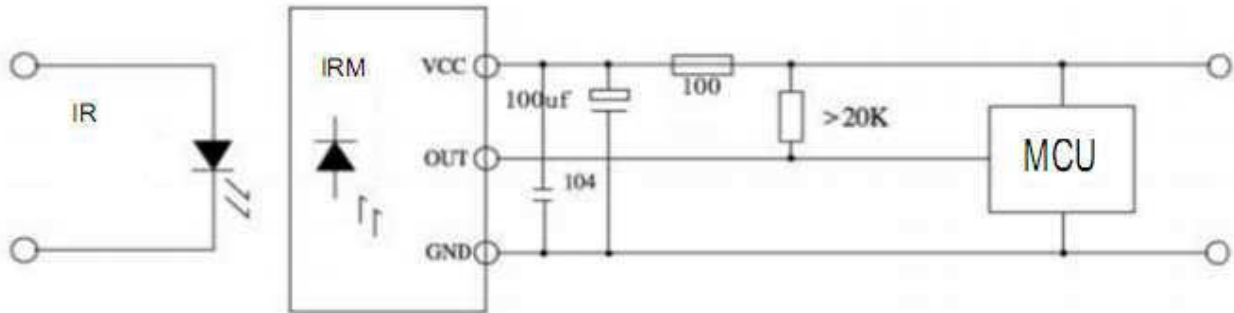
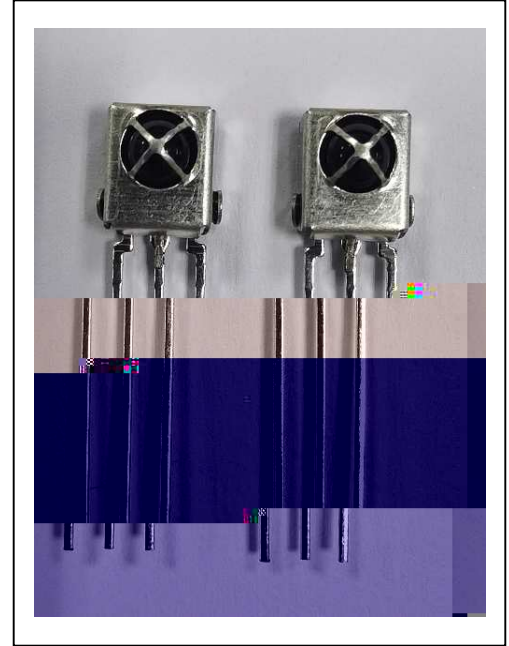

		Min	Typ	Max	
Icc		No Input Signal			mA
L	0°	16	18	---	m
	45°	8	9	---	
	45°	8	9	---	
f ₀		---	37.9	---	kHz
BPF	fbw	fin=37.9kHz			kHz
BPF	fc	-5	f ₀	+5	%
Vol		Iosink=2.0mA			V
Voh		---			V
Av_max		fin=37.9kHz			dB
Rpul		---			k
Tp _w		Vin =500 pp			μs

1m 40W

200±50Lux

Toshiba/NEC/Mitsubishi/RC5_Philips/Sony 12bit/Zenith/RC6/Continuous Code/Sony 15bit/
Sony 20bit/RCA/RCMM.

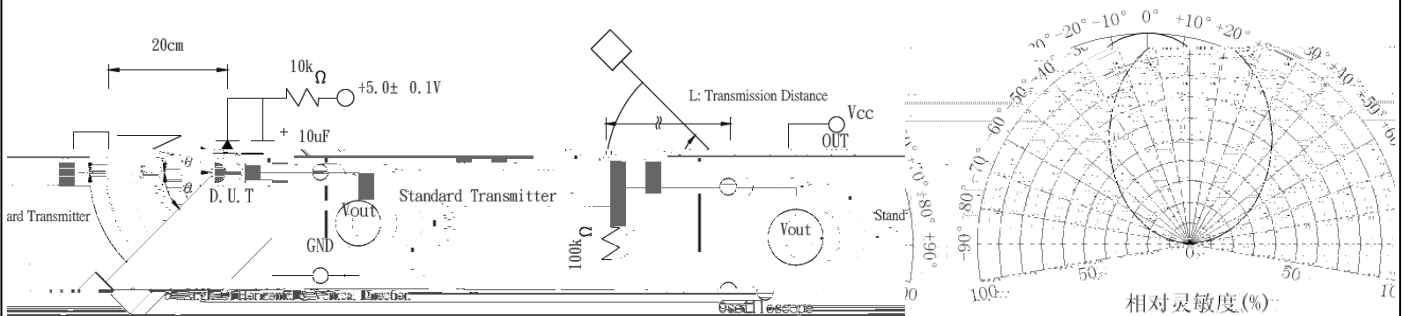

	Min.	Typ.	Max.	
V _{DD}	2.7	---	5.5	V
FM	---	37.9	---	kHz
Topr	---	25	---	

	V _{DD}	6.0	V
	Tstg	-40~100	
	Tsol	260±5 5S	

*

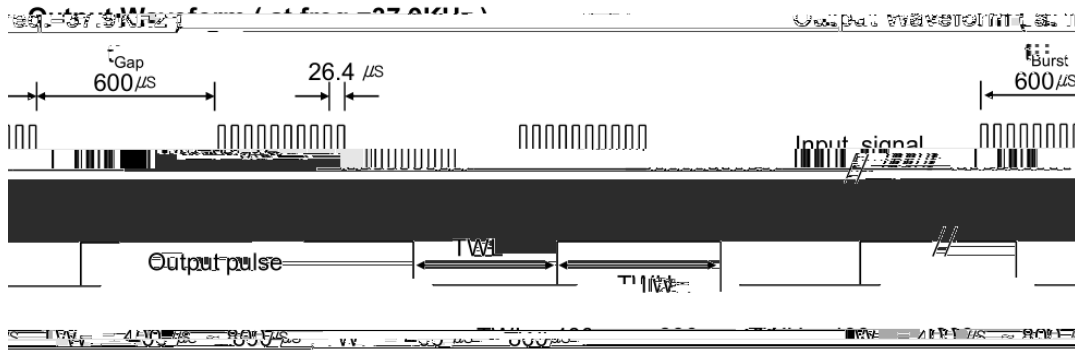

ended for optimal function.

* t_{pi} ≥ 10/f₀ is recomm

Minimum Burst Length t _{burst} (number of pulses per burst)	200us
Minimum Burst Gap time t _{burst_gap} (number of pulses per burst) between two burst	300us

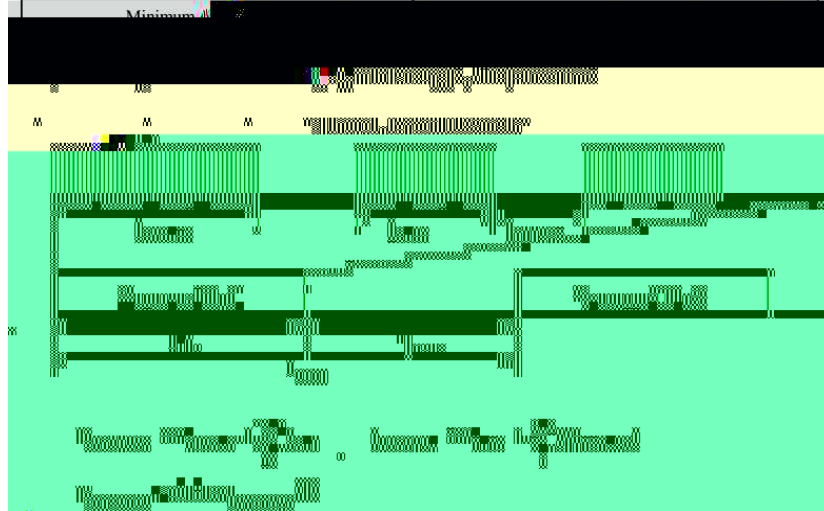

	260 ±5	5	20	20
	100PF, 1.5k , 4KV,	---	20	20
	10-50Hz/1min 1.5mm X Y Z/30min	30	20	20
	85 ±3	240	20	20
	-20 ±3	240	20	20
	85 85%	240	20	20
	-20 30 85 30	10	20	20
	2.5N 2	---	20	20

LIG

LIGHT ELECTRONICS CO., LTD.

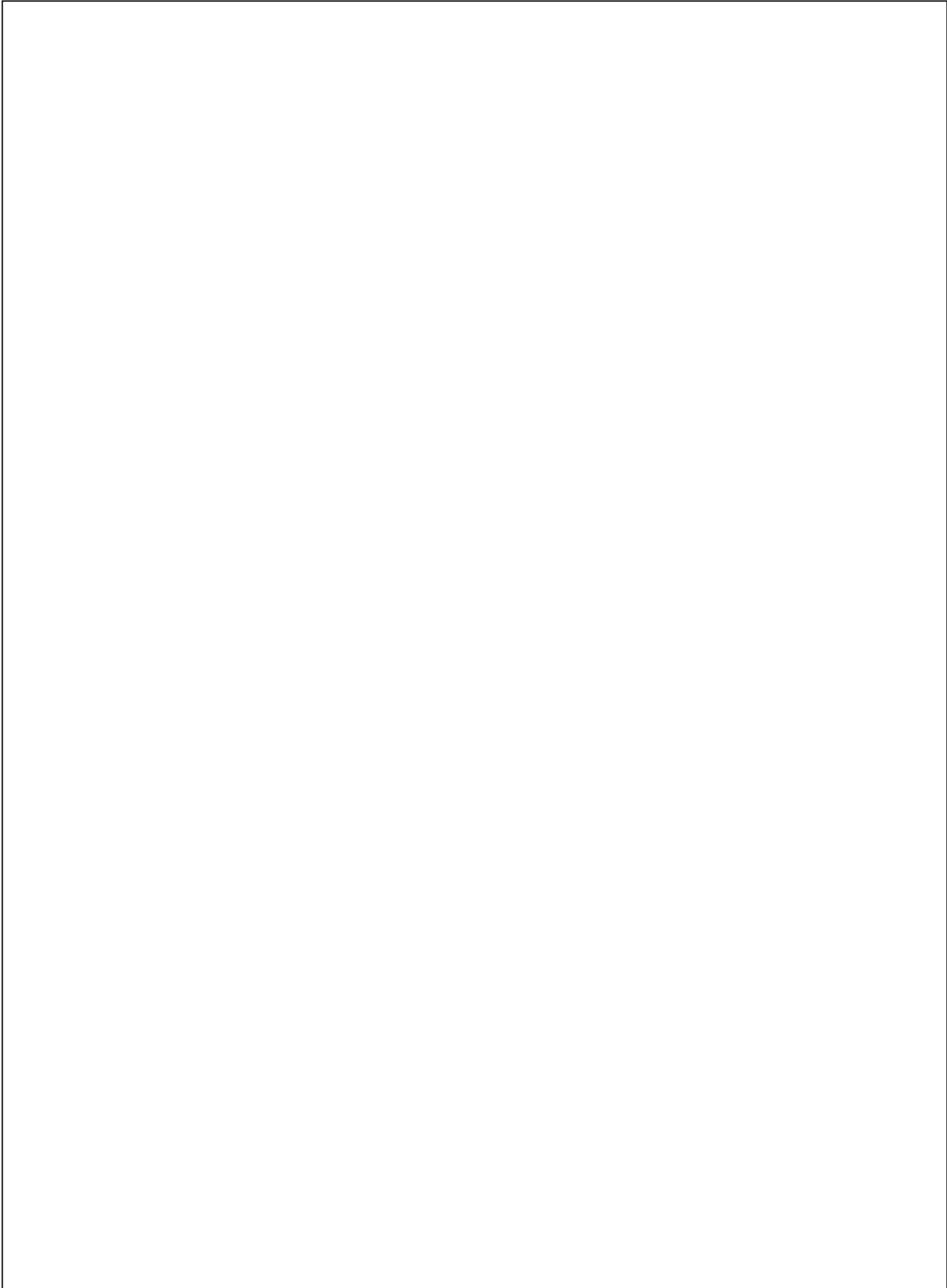

--	--	--	--

1

150mm × 190mm

500PCS

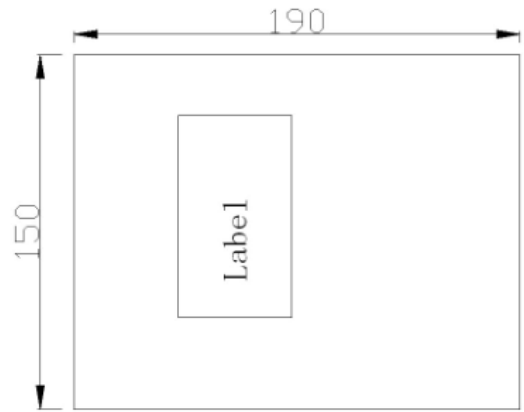

2

500pcs/

10 /

4 /

